



Red Lion®

RAM® 6021 & RAM® 6021M12 Industrial Wired Routers

Hardware Guide | May 2018

LP1068A

©2018 Red Lion Controls, Inc. All rights reserved. Red Lion, the Red Lion logo and Sixnet are registered trademarks of Red Lion Controls, Inc. All other company and product names are trademarks of their respective owners.

Red Lion Controls, Inc.

20 Willow Springs Circle

York, PA 17406 USA

CONTACT INFORMATION:

Inside US: +1 (877) 432-9908

Outside US: +1 (717) 767-6511

Website: www.redlion.net

Email: support@redlion.net

Table of Contents

Preface	iii
Disclaimer	iii
Purpose	iii
Audience	iii
Compliance Statements, Certifications & User Information	iii
FCC Compliance Statement	iii
User Compliance Information	iv
Canadian Compliance Statement	iv
Regulatory Information	iv
Product Safety	iv
Emissions	v
Immunity	v
Rail	v
Designed In Compliance	v
Other	v
Trademark Acknowledgments	v
Release Notes and Document Updates	v
Publication History	vi
Related Documents	vi
Document Comments	vi
Additional Product Information	vi
Safety Information	vi
Warnings/Cautions/Notes	vi
Hazardous Location and Installation Requirements	vii
AVERTISSEMENTS POUR INSTALLATION ET ENDROITS DANGEREUX	vii
Product Overview	1-1
Product Highlights	1-1
RAM® 6021/ RAM® 6021M12	1-1
RAM-6021 Specifications	1-2
RAM-6021 Features and Benefits	1-2
RAM-6021 General Specifications	1-3
RAM-6021 Dimensions	1-4
RAM-6021 Power Connectors and Pin-Outs	1-5
RAM-6021 Power Specifications	1-5
RAM-6021 Electrical Specifications	1-6
RAM-6021 Front View	1-6
RAM-6021 Input and Output Connectors	1-7



RAM-6021 Indicators	1-7
RAM-6021 RESET Button	1-8
RAM-6021M12 Specifications	1-9
RAM-6021M12 Features and Benefits	1-9
RAM-6021M12 Specifications	1-10
RAM-6021M12 Dimensions	1-11
RAM-6021M12 Front View	1-12
RAM-6021M12 Power Connector and Pin-Outs	1-12
Power Specifications	1-12
RAM-6021M12 Electrical Specifications	1-13
RAM-6021M12 Input and Output Connectors	1-14
RAM-6021M12 Indicator Lights	1-15
RAM-6021M12 RESET Button	1-15
Ordering Guide	1-16
Hardware Installation	2-17
Mounting the RAM-6021 Wired Router	2-17
DIN-Rail Mounting & Removal	2-17
Ethernet Cable	2-18
USB Cable	2-18
Serial Cable	2-19
Power Source	2-19
Powering the Router	2-20
Testing the Power Connection	2-20
Mounting the RAM-6021M12 Wired Router	2-21
RAM-6021M12 DIN -Rail Mounting & Removal	2-21
RAM-6021M12 Bulkhead Mounting & Removal	2-21
Ethernet Cable	2-22
USB Cable	2-23
I/O Cable	2-23
Serial Cable	2-23
Power Source	2-24
Powering the Router	2-24
Testing the Power Connection	2-24
Service and Support Information	2-25
Service Information	2-25
Product Support	2-25
Statement of Limited Warranty	2-27



Preface

Disclaimer

Portions of this document are intended solely as an outline of methodologies to be followed during the maintenance and operation of the RAM-6021 equipment/software. It is not intended as a step-by-step guide or a complete set of all procedures necessary and sufficient to complete all operations.

While every effort has been made to ensure that this document is complete and accurate at the time of release, the information that it contains is subject to change. Red Lion Controls is not responsible for any additions to or alterations of the original document. Industrial networks vary widely in their configurations, topologies, and traffic conditions. This document is intended as a general guide only. It has not been tested for all possible applications, and it may not be complete or accurate for some situations.

Users of this document are urged to heed warnings and cautions summarized at the front of the document, such as electrical hazard warnings.

Purpose

This manual gives specific information on how to install and connect the Red Lion RAM-6021 and RAM-6021M12 routers. The RAM-6021M12 model is a RAM-6021 router with in a rugged IP67, dust-proof and water resistant metal enclosure designed to withstand harsh environments.

Audience

The manual is intended for use by qualified personnel who are responsible for installing and maintaining network equipment in an industrial environment.

Compliance Statements, Certifications & User Information

FCC Compliance Statement

This equipment has been tested and found to comply with the limits for a Class A digital device, pursuant to part 15 of the FCC rules.

These limits are designed to provide reasonable protection against harmful interference when the equipment is operated in a commercial environment.

This equipment generates uses and can radiate radio frequency energy; and if not installed and used in accordance with the instructions, may cause harmful interference to radio communications.



Operation of this equipment in a residential area is likely to cause harmful interference to radio communications, in which case the user will be required to correct the interference at their own expense.

Warning: Changes or modifications to this unit not expressly approved by the party responsible for compliance could void the user's authority to operate the equipment.

Avertissement: Tout changement ou modification apporté à cette unité et non expressément approuvé par la partie responsable de la conformité pourrait annuler l'autorisation d'utilisation de l'équipement.

Per FCC requirements the antenna gain including cable loss must not exceed 7.5 dBi in the cellular band, 3 dBi in the PCS band, 5.5 dBi for LTE Band 4, and 9 dBi in the LTE Band 17 for RF exposure purposes of 2.1091. The antenna(s) used for this transmitter must be installed to provide a separation distance of at least 20 cm from all persons. The antenna(s) used for this transmitter must not be co-located or operating in conjunction with any other antenna or transmitter except in accordance with FCC multi-transmitter evaluation procedures

User Compliance Information

If this equipment causes interference to radio or television reception, which can be determined by turning the equipment off and on, the user is encouraged to try to correct the interference by one or more of the following measures:

In order to meet FCC emissions limits, this equipment must be used only with cables that comply with IEEE 802.3.

If necessary, the user should consult the dealer or an experienced radio/television technician for additional suggestions.

The user may find the following booklet prepared by the Federal Communications Commission helpful:

“How to Identify and Resolve Radio-TV Interference Problems”.

This booklet is available from: U.S. Government Printing Office, Washington DC, 20402 Stock No. 004-000-00345-4.

Canadian Compliance Statement

This Class A digital apparatus meets all requirements of the Innovation, Science and Economic Development Canada ICES-003.

Cet appareil numérique de la classe A respecte toutes les exigences de la science, l'innovation et de Développement économique Canada ICES-003.



Regulatory Information

Product Safety

RAM-6021

ANSI / ISA12.12.01/CSA22.2/213 (CUL) Class I, Div. 2, Groups A, B, C, and D Hazardous Locations

UL508/CSA22.2/142 (CUL), (CE) - IEC61010-1 Electrical Safety

Pollution Degree 2 and Overvoltage Category II

RAM-6021M12

ANSI/ISA 12.12.01-2015 Class I and II, Div. 2 and Class III, Div. 1 and 2, Groups A, B, C and D Hazardous Locations

UL508 17th Ed. Industrial Control Equipment

CAN/CSA-C22.2 No. 213-16 Class I Div. 2 Hazardous Locations

CAN/CSA-C22.2 No. 14-13 Industrial Control Equipment

Emissions

RAM-6021

EN55022, FCC Title 47, Part 15, Radio Frequency Devices, Subpart B; Industry Canada ICES-003

RAM-6021M12

FCC Title 47, Part 15, Radio Frequency Devices, Subpart B ANSI C63.4-2014; Industry Canada ICES-003, EN 61000-6-4, EN 61000-3-2, EN61000-3-3

Immunity

RAM-6021

ETSI EN 301 489-7 and -24 (Includes EN61000-4-2, 3, 4, 5 and 6)

RAM-6021M12

EN 61000-6-2; IEC 61000-4-2 (ESD); IEC 61000-4-3 (RFAM); IEC 61000-4-4 (EFT); IEC 61000-4-5 (SURGE); IEC 61000-4-6 (RFCM); IEC 61000-4-8 (PFMF); IEC 61000-4-11 (VDI)

Rail

RAM-6021M12

EN 50155, EN 50121, EN 61373 and EN 45545-2



Designed In Compliance

RAM-6021M12

IEEE 1613 (Electric Utility Substations), NEMA TS1/TS2 (Traffic Control)

Other

RAM-6021

RoHS Compliant

WEEE Compliance- These devices comply with the WEEE directive. Do not throw away these devices in the standard trash. Contact Red Lion Controls with questions regarding proper disposal.

RAM-6021M12

EMC Directive 2014/30/EU; LV Directive 2014/35/EU, Restriction of Hazardous Substance 2011/65/EU, RoHS Compliant, ABS Type Approval for Shipboard Applications.

WEEE Compliance- These devices comply with the WEEE directive. Do not throw away these devices in the standard trash. Contact Red Lion Controls with questions regarding proper disposal.

Trademark Acknowledgments

Red Lion Controls acknowledges and recognizes ownership of the following trademarked terms used in this document.

- Windows® /98/2000/7/8, Windows XP® are registered trademarks of the Microsoft Corporation.
- Microsoft is either a registered trademark or trademark of Microsoft Corporation in the United States and/or other countries.
- Ethernet™ is a registered trademark of Xerox Corporation.
- All other company and product names are trademarks of their respective owners.

Release Notes and Document Updates

The hard copy and flash drive versions of this document are revised only at major releases and, therefore, may not always contain the latest product information. As needed, Tech Notes and or Product Bulletins will be provided between major releases to describe any new information or document changes.

The latest online version of this document and all product updates can be accessed through the Red Lion web site at www.redlion.net/documentation



Publication History

The following information lists the release history of this document.

Issue/Revision	Release Date	Content Description
Revision A	May 2018	Applied formatting updates and standardized content. Added RAM-6021M12 model.
Initial Release	April 2014	Modifications to power specifications. Included installation and hazardous area warnings.

Related Documents

The following information lists available documents related to this product.

Issue/Revision	Release Date	Document Title
LP0979 Revision C	September 2017	RAM-6021 Software Manual
LP1043 Revision A	September 2017	RAM-6021 Quick Start Guide
LP1061 Revision A	February 2018	RAM-6021M12 Quick Start Guide

Document Comments

Red Lion appreciates all comments that will help us to improve our documentation quality. The user can submit comments through the Red Lion Customer Service. Simply email us at customer.service@redlion.net.

Additional Product Information

Additional product information can be obtained by contacting the local sales representative or Red Lion through the contact numbers and/or e-mail addresses listed on the back of the cover.

Safety Information

	<p>WARNING – Must consult the guide in all cases where this symbol is marked.</p> <p>AVERTISSEMENT - Doivent consulter le guide dans tous les cas où ce symbole est marqué.</p>
---	---

Warnings/Cautions/Notes

Warnings apply to situations where personal injury or death may result.

Mises en garde s'appliquent aux situations où les risques de blessures graves ou mortelles peuvent en résulter

Cautions apply where damage to equipment may result.

Les mises en garde s'appliquent dans le cas où les dommages matériels peuvent en résulter



Notes apply where additional noteworthy information, not in the general text flow but applicable, is made available to the user.

Notes s'appliquent lorsque des informations dignes de mention, non pas dans l'enchaînement du texte mais il y a lieu, est mis à la disposition de l'utilisateur

Hazardous Location and Installation Requirements

These products should not be used to replace proper safety interlocking. No software-based device (or any other solid-state device) should ever be designed to be responsible for the maintenance of consequential equipment or personnel safety. In particular, Red Lion disclaims any responsibility for damages, either direct or consequential, that result from the use of this equipment in any application.

All power, input and output (I/O) wiring must be in accordance with Class I, Division 2 wiring methods and in accordance with the authority having jurisdiction. Suitable for use in Class I, Division 2, Groups A, B, C and D hazardous locations, or non-hazardous locations only.

AVERTISSEMENTS POUR INSTALLATION ET ENDROITS DANGEREUX

Ces produits ne doivent pas être utilisés pour remplacer le verrouillage de sécurité approprié. Aucun dispositif basé sur un logiciel (ou tout autre dispositif à l'état solide) devraient jamais être conçus pour être responsable de l'entretien de l'équipement consécutifs ou la sécurité du personnel. En particulier, Red Lion décline toute responsabilité pour les dommages, directs ou indirects, résultant de l'utilisation de cet équipement dans n'importe quelle application.

Tout pouvoir, le câblage d'entrée et de sortie (I/O) doivent être conformes aux méthodes de câblage de Classe 1, Division 2 et conformément à l'autorité compétente. Cet équipement est adapté pour une utilisation en Classe 1, Division 2, Groupes A, B, C et D ou endroits non-dangereux seulement.

	<p>WARNING: Explosion Hazard – Substitution of components may impair suitability for Class I, Division 2.</p> <p>AVERTISSEMENT - Risque d'explosion - La substitution de tout composant peut nuire à la conformité de Classe 1, Division 2.</p>
---	---

	<p>Warning – Do not remove or replace port connections while circuit is live unless the area is known to be free of ignitable concentrations of flammable substances. For the required marking for the port connections, instruction shall be included indicating that the marking shall be displayed on a prominent place on the end-enclosure..</p> <p>Avertissement – Ne pas retirer ou remplacer les connexions de port alors que le circuit est vivre à moins que la région est connue pour être libre d'ignitable les concentrations de substances inflammables. pour le marquage obligatoire pour les connexions de port, l'enseignement doit être inclus en indiquant que le marquage doit être affichée sur une place de premier plan dans l'enceinte.</p>
---	---

	<p>WARNING – Explosion Hazard – Do not disconnect equipment unless power has been switched off or the area is known to be non-hazardous.</p> <p>AVERTISSEMENT - Risque d'explosion - Ne débranchez pas l'équipement à moins que l'alimentation ait été coupée ou que l'environnement est connu pour être non dangereux.</p>
---	---



WARNING – DC 2.5mm Barrel Connector shall not be used in hazardous locations.
AVERTISSEMENT - Connecteur 2.5mm DC ne doit pas être utilisé dans des endroits dangereux.

RAM-6021M12 Model Only

These devices are open-type devices that are to be installed in a tool only accessible enclosure suitable for the environment.

T-Code of T4A was established

Ces appareils sont de type ouvert matériels qui doivent être installés dans un boîtier de l'outil accessible uniquement adapté à l'environnement

T-Code de T4A a été établie.

Chapter 1 Product Overview

With a rugged design and flexible platform, the RAM-6021 industrial secure router provides the ability to remotely connect, monitor and control assets across a variety of industrial applications. The RAM-6021's web based event engine can be customized to trigger I/O or email alerts, to quickly notify personnel of critical events based on operational data. Add in robust security features, which include a stateful firewall, NAT translations and VPN connections, and the RAM-6021 delivers a compact all-in-one solution that seamlessly connects to existing Ethernet infrastructures, including networks with Modbus and DNP3 enabled devices.

The router is also available as a RAM-6021M12 industrial secure model with an IP67 rating.

The RAM-6021M12 industrial LAN router offers secure routing, VPN tunneling and NAT (network address translation) for secure LAN to LAN and LAN to WAN communication. Housed in a rugged IP67, dust-proof and water resistant metal enclosure, the RAM-6021M12 is designed to withstand harsh industrial environments including temporary immersion in water, exposure to low/high pressure water jets, and extreme shock and vibration levels, making it ideal for industries where hardened products are required.

1.1 Product Highlights

1.1.1 RAM[®] 6021/ RAM[®] 6021M12

- Secure network routing and communication
- LAN-to-LAN or LAN-to-WAN connectivity
- Integrated security firewall provides intrusion protection
- NAT support for 1-to-1 and 1-many translations
- Native support for DNP3 and Modbus protocols
- Powerful event engine to trigger I/O or send email alerts based on real-time operational data.
- Rugged industrial design in a compact package
- IP67 rated, dust-proof and water resistant, hardened metal enclosure*
- Bulkhead mountable*

* Denotes RAM-6021M12 only



1.2 RAM-6021

All specifications are subject to change. Consult the Red Lion Controls website for more information.

1.2.1 RAM-6021 Features and Benefits

Features and Benefits

Built-in security and routing protects against unwanted intrusion

- Intrusion protection and secure data access
- Stateful firewall
- Access Control List (ACL)
- IPsec and SSL VPN tunnels
- Port forwarding
- Packet filtering

Flexible all-in-one platform reduces complexity

- Remote TCP/IP based capabilities
- Integrated switching and routing
- Serial-to-IP conversion
- Access IP and serial devices simultaneously

Redundant power inputs (8-30 VDC)

Rugged, compact design deploys easily in space-constrained locations

- -40 to 70 °C operating temperature range
- Ingress IP30 protection
- DIN-rail mounting

Remote monitoring and control eliminates site visits

- Instant access to SCADA data
- Modbus and DNP3 (serial and IP protocol support)
- Simple integration for complex configurations

Intuitive web-based interface simplifies management and configuration

- Syslog
- Built-in data capture for enhanced troubleshooting
- Key metric reporting
- RAMQTT for cloud connectivity



1.2.2 RAM-6021 Specifications

Mechanical				
Height	Width	Depth	Weight	Mount
4.70" (11.94 cm)	2.00" (5.08 cm)	3.77" (9.58 cm)	1.2 lbs (0.544 kg)	35mm DIN-Rail
Power Input				
Input Voltage	Steady Input Current	Power Consumption	Redundant Power Input	
8-30 VDC	150 mA @30 VDC	4.5W typical max.with all ports linked	4-pin screw terminal Side mounted 2.5 mm barrel connector <ul style="list-style-type: none"> • 8-30 VDC (nominal) • Input current (max): 150mA 	
Environmental				
Operating Temperature	Storage Temperature	Operating Humidity		Operating Altitude
-40 to 70 °C	-40 to 85 °C	5% to 95% (non condensing)		Up to 2000 m per IEC61010-1
Shock and Vibration / Reliability				
Shock	Vibration		MTBF	
IEC 60068-2-27	IEC 60068-2-6		1,832K Hours GB @ 40°C per MIL-HNDBK-217F2	
Network Media				
10Base-T	≥CAT3 Cable			
100Base-TX	≥CAT5 Cable			
Recommended Minimum Wiring Clearance				
Front	4" (10.16 cm)			
Interfaces / Connectors				
Ethernet 10/100 Auto-Sensing		Serial	USB	I/O
5x RJ45 (port 5 – WAN/LAN capability)		1x RS-232 Serial DB9 115200bps	1x USB 2.0 mini configuration port	1x digital output 1x digital/analog input (one active)
Switch Properties				
IP	Protocol Gateway	Tunneling	Data Throughput	
NAT, port forwarding, dynamic DNS, DHCP Stateful inspection firewall, IP transparency Routing Protocols: OSPF, BGP, RIP, VRRP Encapsulation Protocols: GRE	Modbus RTU/TCP/ ASCII RTU DNP3 - slave	IPsec and SSL	LAN ports: 100 Mbps WAN port: 45 Mbps	

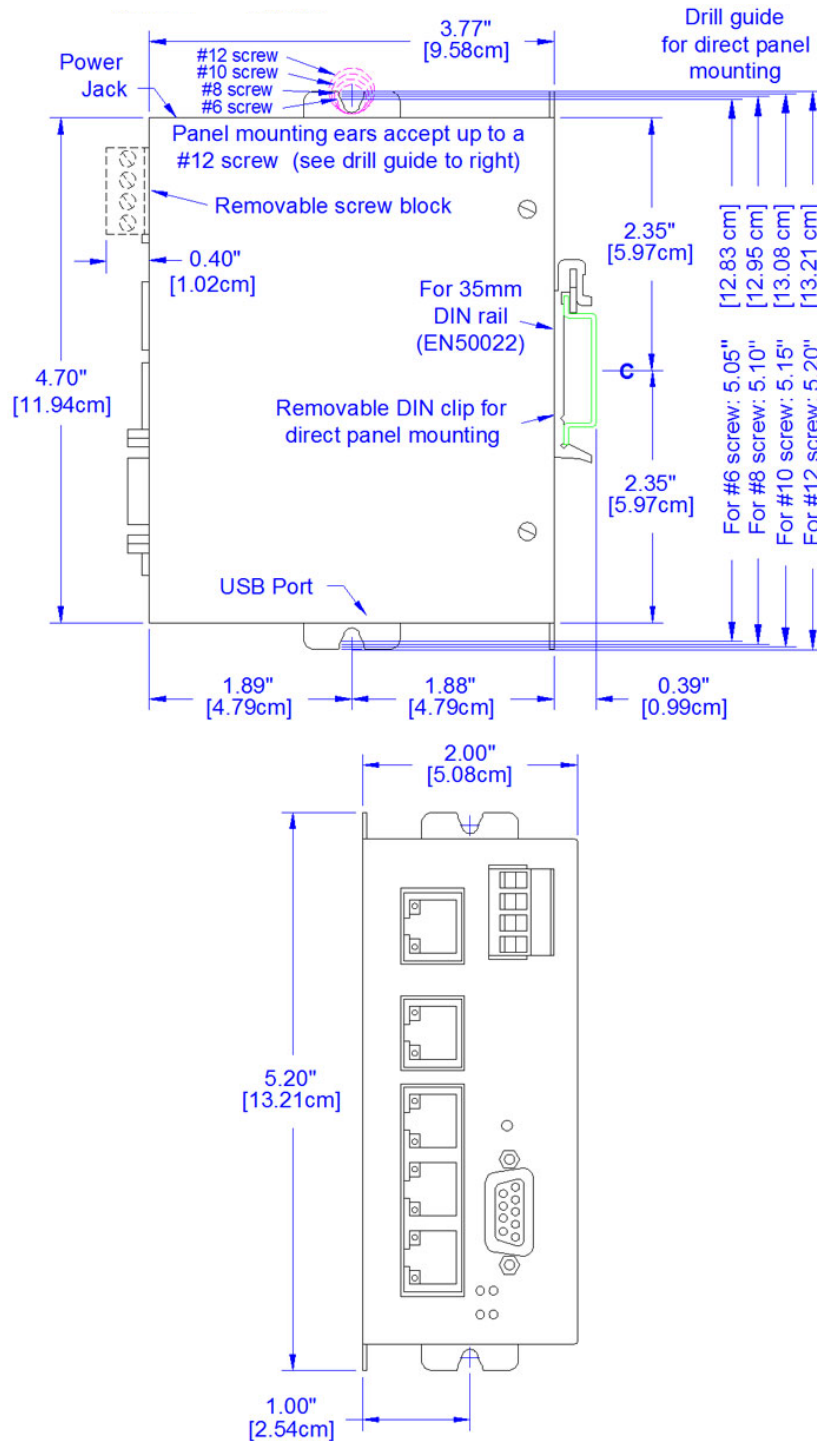

1.2.3 RAM-6021 Dimensions



All specifications are subject to change. Consult the company website for more information.

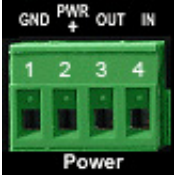

1.2.4 RAM-6021 Power Connectors and Pin-Outs

Power Input Connectors / Pin-outs			
Model / Connector	Pin	Name	Description
 <p>4-Pin Screw Connector</p>	1	GND	Ground
	2	PWR+	Power supply input (8 to 30 VDC) (500mA@12VDC)
	3	OUT	Digital output
	4	IN	Digital and analog input
 <p>DC 2.5mm Barrel Connector</p>	Sleeve	GND	Ground
	Tip	PWR+	Power supply input (8 to 30 VDC)



WARNING – DC 2.5mm Barrel Connector shall not be used in hazardous locations.
AVERTISSEMENT - Connecteur 2.5mm DC ne doit pas être utilisé dans des endroits dangereux.

1.2.5 RAM-6021 Power Specifications

Power input to the router is protected against reverse polarity and power surges over 33VDC. The routers are equipped with an internal 3 Amp fuse.

The router's power consumption is:

MODEL	DRAW IN MA (AT 12 VDC)		
	STANDBY	TRANSMITTING	PEAKS
RAM-6021	115	360	531

Note: Wiring instructions are provided in Chapter 2.

Note: To meet UL requirements, a “Class 2 Source” power supply is required.

1.2.6 RAM-6021 Electrical Specifications





1x Digital Output (DOUT)	
Configuration	Open collector, reference to ground
Absolute Maximum IDC	500mADC (Vce = 750mVDC)
Absolute Maximum VDC	30VDC (open circuit)
Absolute Minimum VDC	-0.4VDC (open circuit)
1x Digital Input (DIN)	
Configuration	Un-isolated level detection, reference to ground
Active level	1.6VDC to 30VDC
Inactive level	0VDC to 1.3VDC
Absolute Minimum VDC	-0.3VDC
Absolute Maximum VDC	33VDC
Leakage IDC at 5VDC	150uADC
1x Analog Input (Shared with Digital Input) (DIN/AI1)	
Configuration	Un-isolated input, reference to ground
Resolution	1024 (ADC 10-bit)
VDC per step	4.8875855mVDC
Full scale level	5VDC
Zero level	0VDC
Absolute Minimum VDC	-0.3VDC
Absolute Maximum VDC	8.3VDC
Leakage IDC at 5VDC	265.96uADC TYPE

1.2.7 RAM-6021 Front View

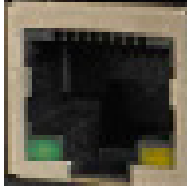

RAM-6021

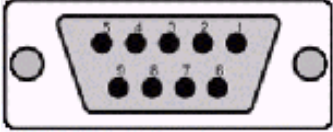
1.2.8 RAM-6021 Input and Output Connectors

Input/Output Ports			
Model / Connector	Connector Type	Name	Description
RAM-6021  LAN/WAN Connector	RJ45	Ethernet port	The router's 10/100Mbps Ethernet port is compliant with the EIA-568 standard. The router's ports are auto-sensing so they can be used with either a straight or crossover RJ45 cable to connect to host ports
RAM-6021  RS232 Connector	DB9	Serial port	The router's serial port is an RS232 DCE, compliant with EIA-232 standard. The connector used is DB9 female. 
RAM-6021  USB Connector	Mini B	USB 2.0 interface port	This is a USB 2.0 Device interface on a Mini B connector. It offers Ethernet-over-USB functionality using the RNDIS driver for Windows XP and Windows Vista Operating systems only. The BlueTree RNDIS driver must be installed before the USB interface can be used. The driver and instructions can be obtained at www.redlion.net . Note: With firmware version 4.17 and later, standard Windows RNDIS drivers are used and no additional driver is required from www.redlion.net

1.2.9 RAM-6021 Indicators

LED	STATUS	CORRESPONDING STATE
Power	ON	Router is powered on.
	OFF	Router is powered off.
	FLASH	Firmware error
W (Reset)		View section 1.2.8 for further details.
RS232	ON	Link established with serial device but no data activity.
	OFF	Connection is not established.
	FLASH	Data transmitted/received (Depends on serial application)
Ethernet Link/ Activity	ON	Link established with Ethernet device.
	OFF	Connection is not established.
	FLASH	Data transmitted/received.

1.2.10 RAM-6021 RESET Button

MODE	PATTERN	DESCRIPTION
Hard reset	Press and hold for less than 3 seconds	Standard reboot
Factory restore	Press and hold between 3 and 10 seconds RS232 LED flashes quickly	To restore default settings for older versions, rerun the SN Reflashing procedure found at www.redlion.net
FW upgrade	Press and hold between 10 and 15 seconds W LED flashes quickly	Puts the router in advanced firmware upgrade mode by restarting the router and running the boot loader only. Do not use this mode unless instructed to by Red Lion Technical Support

1.3 RAM-6021M12

All specifications are subject to change. Consult the Red Lion Controls website for more information.

1.3.1 RAM-6021M12 Features and Benefits

Features and Benefits

Built-in security and routing protects against unwanted intrusion

- Intrusion protection and secure data access
- IPsec and SSL VPN tunnels
- Port forwarding
- Stateful firewall
- Packet filtering
- Access Control List (ACL)

Flexible all-in-one platform reduces complexity

- Remote TCP/IP based capabilities
- SNMP V1, V2, V3
- Serial-to-IP conversion
- Access IP and serial devices simultaneously

Full IEEE 802.3 compliance

ESD protection on all ports

Redundant power inputs (8-49 VDC)

Surge protection on power inputs

Extended Environmental Specifications

- -40 to 80 °C operating temperature range

Bulkhead mountable

Rugged compact IP67 hardened enclosure

IP67 protection

- Protection against low/high pressure water jets
- Temporary immersion in water
- Dust proof

Remote monitoring and control eliminates site visits

- Instant access to SCADA data
- Modbus and DNP3 (serial and IP protocol support)
- ID routing to existing Modbus hardware

Intuitive web-based interface simplifies management and configuration

- Syslog
- Built-in data capture for enhanced troubleshooting
- Key metric reporting
- RAMQTT for cloud connectivity



1.3.2 RAM-6021M12 Specifications

Mechanical				
Height	Width	Depth	Weight	Mount
5" (12.7 cm)	4.32" (10.97 cm)	2.1" (5.33 cm)	1.75 lbs (0.79 kg)	Bulkhead; Optional 35mm DIN-Rail
Power Input				
Input Voltage	Steady Input Current	Inrush Current	BTU/hr	
8-49 VDC	0.15 A @ 24 VDC	33.9Amp/0.0287ms @ 24VDC	12.25	
Environmental				
Operating Temperature	Storage Temperature	Operating Humidity		Operating Altitude
-40 to 80 °C	-40 to 85 °C	10% to 95% (non condensing)		0 to 10,000 ft
Shock and Vibration / Reliability				
Shock	Vibration		MTBF	
IEC 60068-2-27 200g @ 10ms (Bulkhead mounted)	IEC 60068-2-6 50g, 5-200Hz (Bulkhead mounted)		1,832K Hours GB @ 40°C per MIL-HNDBK-217F2	
Network Media				
10Base-T	≥CAT3 Cable			
100Base-TX	≥CAT5 Cable			
Recommended Minimum Wiring Clearance				
Front	4" (10.16 cm)			
Interfaces / Connectors				
10/100BaseTX	Serial and IO		USB	Power
Five M12 4-pin D-code connectors	One M12 8-pin A-code connector 5-Pin Serial 1x digital output 1x digital/analog input (one active)		One M12 Type B mini-B	One 4-pin M12 A-code connector with two redundant inputs
Switch Properties				
IP	Protocol Gateway		Tunneling	Data Throughput
NAT, port forwarding, dynamic DNS, DHCP Stateful inspection firewall, IP transparency Routing Protocols: OSPF, BGP, RIP, VRRP Encapsulation Protocols: GRE	Modbus RTU/TCP/ ASCII RTU DNP3 - slave		IPsec and SSL	LAN ports: 100 Mbps WAN port: 45 Mbps



1.3.3 RAM-6021M12 Dimensions

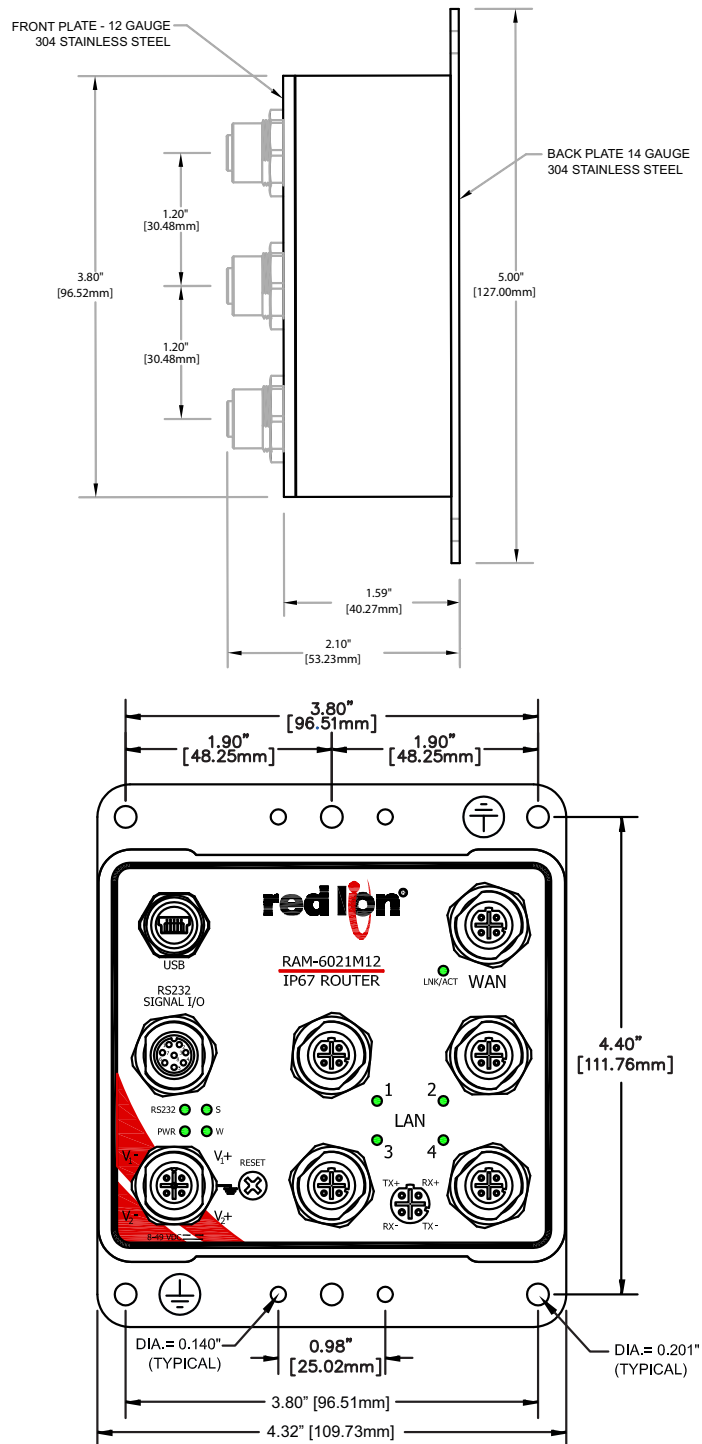

All specifications are subject to change. Consult the company website for more information.



1.3.4 RAM-6021M12 Front View



RAM-6021M12

1.3.5 RAM-6021M12 Power Connector and Pin-Outs

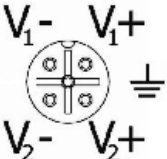
Power Input Connector / Pin-outs			
Model / Connector	Pin	Description	Name
 <p>5-Pin Power Connector</p>	1	Voltage 1+	V1+
	2	Voltage 1-	V1-
	3	Voltage 2 -	V2-
	4	Voltage 2+	V2+
	5	Case Ground	Case Ground

1.3.6 RAM-6021M12 Power Specifications

Power input to the router is protected against reverse polarity and power surges over 57VDC.

The router's power consumption is:



MODEL	DRAW IN MA (AT 12 VDC)		
	STANDBY	TRANSMITTING	PEAKS
RAM-6021M12	90	200	300

Note: Wiring instructions are provided in Chapter 2.

1.3.7 RAM-6021M12 Electrical Specifications

1x Digital Output (DOUT)	
Configuration	Open collector, reference to ground
Absolute Maximum IDC	500mADC (Vce = 750mVDC)
Absolute Maximum VDC	49VDC (open circuit)
Absolute Minimum VDC	-0.4VDC (open circuit)
1x Digital Input (DIN)	
Configuration	Un-isolated level detection, reference to ground
Active level	2.5VDC to 30VDC
Inactive level	0VDC to 1.3VDC
Absolute Minimum VDC	-0.3VDC
Absolute Maximum VDC	33VDC
Leakage IDC at 5VDC	150uADC
1x Analog Input (Shared with Digital Input) (DIN/A11)	
Configuration	Un-isolated input, reference to ground
Resolution	1024 (ADC 10-bit)
VDC per step	4.8875855mVDC
Full scale level	5VDC
Zero level	0VDC
Absolute Minimum VDC	-0.3VDC
Absolute Maximum VDC	8.3VDC
Leakage IDC at 5VDC	265.96uADC TYPE

1.3.8 RAM-6021M12 Input and Output Connectors

Input/Output Connectors			
Model / Connector	Pin	Name	Description
 M12 D-Code 4-Pin Ethernet WAN/LAN Connector	1	TX+	Transmit output
	2	RX+	Receive input
	3	TX-	Digital transmit output
	4	RX-	Digital receive input
 M12 D-Code 8-Pin Serial RS232 Signal I/O Connector	1	GND	Signal ground
	2	SERIAL_RX	Serial receive input
	3	SERIAL_TX	Serial transmit output
	4	DIGITAL_OUT	Digital transmit output
	5	DIGITAL_IN/ANALOG_IN	Digital receive input, Analog receive input
	6	GND	Signal ground
	7	SERIAL_RTS	Serial Request to Send
	8	SERIAL_CTS	Serial Clear To Send
 M12 mini-b 5-Pin USB 2.0 Connector	1	VCC	+5V from USB Host
	2	USB DATA-	Data -
	3	USB DATA+	Data +
	4	NC	Shorted to GND, N/C, or shorted to GND via resistor
	5	GND	USB ground

1.3.9 RAM-6021M12 Indicators

LED	STATUS	CORRESPONDING STATE
Power	ON	Router is powered on.
	OFF	Router is powered off.
	FLASH	Firmware error
W (Reset)		View section 1.2.8 for further details.
RS232	ON	Link established with serial device but no data activity.
	OFF	Connection is not established.
	FLASH*	Data transmitted/received (* Depends on serial application)
Ethernet Link/ Activity	GREEN	Link established with Ethernet device.
	OFF	Connection is not established.
	ORANGE	Data transmitted/received.

1.3.10 RAM-6021M12 RESET Button

MODE	PATTERN	DESCRIPTION
Hard reset	Press and hold for less than 3 seconds	Standard reboot
Factory restore	Press and hold between 3 and 10 seconds RS232 LED flashes quickly	To restore default settings for older versions, rerun the SN Reflashing procedure found at www.redlion.net
FW upgrade	Press and hold between 10 and 15 seconds W LED flashes quickly	Puts the router in advanced firmware upgrade mode by restarting the router and running the boot loader only. Do not use this mode unless instructed to by Red Lion Technical Support

1.4 Ordering Guide

MODEL NUMBER	PART NUMBER	DESCRIPTION
RAM-6021	RAM-6021	Secure router with five Ethernet ports, one serial port, Modbus/DNP3 gateway
	ET-PS-024-02	DIN-Rail 2 amp power supply
	FPSALACADAPTER2	2.5mm barrel power supply
RAM-6021M12	RAM-6021M12	Secure router with five Ethernet ports, one serial port, Modbus/DNP3 gateway
	NTPS-24-1.3	DIN-Rail power supply 24V @ 1.3 Amp
	M12DRC-ISO	DIN-Rail kit, two isolated plastic clips
	M12DRC-MTL	DIN-Rail kit, two metal clips
	CAT5E STP Cables with M12 connectors	
	CAT5E-M12-M12-X	Straight M12 to Straight M12, Shielded
	CAT5E-M12-RJ45-X	Straight M12 to RJ-45, Shielded
	CAT5E-M12-X	Straight M12 to bare end, Shielded
	CAT5E-RM12-M12-X	90° M12 to Straight M12, Shielded
	CAT5E-RM12-RM12-X	90° M12 to 90° M12, Shielded
	CAT5E-RM12-RJ45-X	90° M12 to RJ-45, Shielded
	PWR-M12-A-X	Power Cable, M12 A-Coded Straight Female to bare end, Shielded
	PWR-RM12-A-X	Power Cable, M12 A-Coded 90° Female to bare end, Shielded
	USBA-M12	6.5' USB Type A to M12 Mini-USB Type B CABLE
	SERIAL-DB9-M12A	M12 A-Code 8-pin to DB9-F Serial Cable 5ft
	CBL-IO-M12A-5	M12 A-Code 8-pin to 3 WR 22 AWG Cable 5ft
	CONN-M12A-1	A-Code M12 Straight 8-pin Connector Pack of 1

Where: X = length of cable, fill in desired amount in feet.
Example: CAT5E-RM12-10 (for a 10 ft cable)

Chapter 2 Hardware Installation

2.1 Mounting the RAM-6021 Wired Router

There are three different ways to mount a RAM-6021 wired router:

- Horizontally using two (2) #6 screws onto its horizontal mounting feet.
- Vertically using two (2) #6 screws onto its vertical mounting feet.
- Vertically on a DIN-Rail using the supplied DIN-Rail clip.

Note: Allow enough room to route the Ethernet, serial, I/O and other cables.

2.1.1 DIN-Rail Mounting & Removal

The RAM-6021 has a DIN-Rail clip pre-mounted to the back of the unit. To panel mount the unit, the clip must be removed by removing the three (3) screws holding it in place. See the image at right for reference.



The DIN clip has an integral spring mechanism that keeps it securely attached to the rail. Refer to the diagrams below for how to mount and remove the unit to a standard EN50022 DIN-Rail.

Note: For best performance it is recommended that a DIN-Rail spacer (such as an end clamp) be used between the RAM-6021 and adjacent devices. This will leave an adequate air gap for proper heat dissipation away from the device case.

Mounting Instructions:

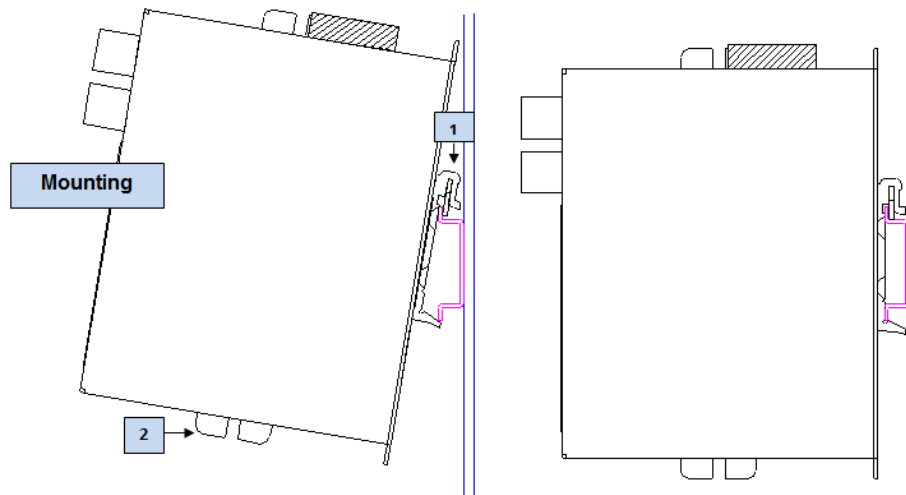

Recommended DIN Rail mounting steps:

1. Hook the top back of the DIN rail clips on the unit over the DIN rail.
2. Push the bottom of the unit towards the DIN rail unit it snaps into place.

Removal Instructions:

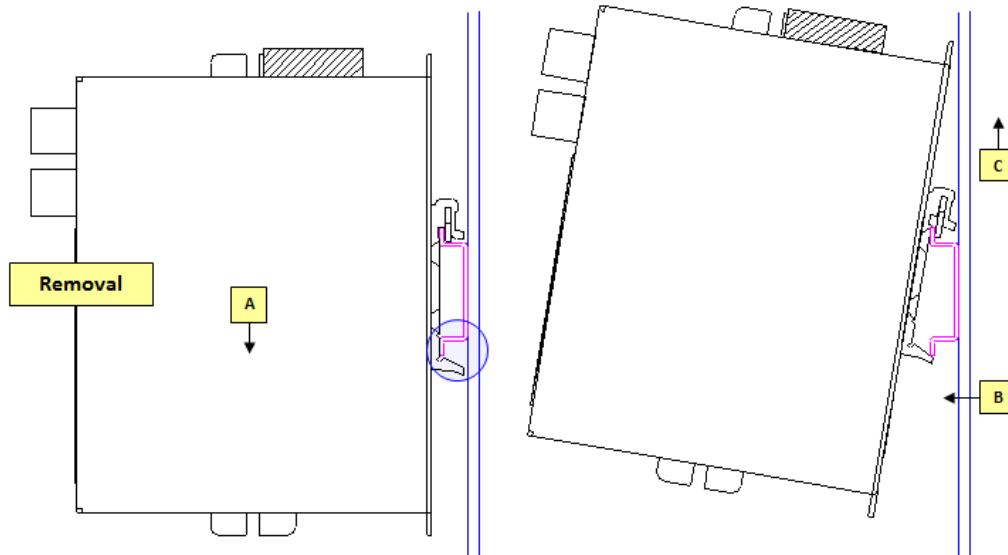

Recommended DIN rail removal steps:

- A. Push the whole unit down to free the bottom of the DIN rail clip. See blue circle area.
- B. Pull the bottom of the unit away from the DIN rail.
- C. Unhook the top of unit and remove it from the DIN rail

2.1.2 Ethernet Cable

If you are connecting to the router via the Ethernet port, you will need a straight or crossover category 5 cable with a 8-pin RJ45 connector on each end.

Note: To visually confirm that Ethernet cabling was done properly, check the LED indication on the Ethernet port located at the rear panel of the router. The Link LED should be on when the correct cable is used.

Note: A shielded cable is required to fully meet EMC standards.

2.1.3 USB Cable

This is an Ethernet-over-USB connection which behaves like an Ethernet connection. It can only be connected to a PC with Windows 7/8 and any other Windows operating system. If you are connecting to the router via the USB port, you will need a Type A plug to Type B plug USB cable for the mini Type B plug to Type A plug for the RAM-6021 wired router. In order for the USB connection to work, you need to install the Sixnet USB driver which is available at www.redlion.net.

Note: With firmware version 4.17 and later, standard Windows RNDIS drivers are used and no additional driver is required from www.redlion.net.

2.1.4 Serial Cable

The router Serial port uses a 5-pin serial (TX/RX and RTS/CTS enabled) cable.

The router is a DCE device, so use a straight-through serial cable between the router and a DTE device such as a terminal. Use a NULL router cable adapter between the router and a DCE device such as another router.

If using custom wiring or if some pins are disabled, follow the guidelines below to wire CONN-M12A-1. The wiring will vary depending on whether the attached serial device is a DTE or DCE.

PIN	NAME	DESCRIPTION
1	GND	Signal ground
2	SERIAL_RX	Serial receive input
3	SERIAL_TX	Serial transmit output
4	DIGITAL_OUT	Digital transmit output
5	DIGITAL_IN/ANALOG_IN	Digital receive input, Analog receive input
6	GND	Signal ground
7	SERIAL_RTS	Serial Request to Send (RTS)
8	SERIAL_CTS	Serial Clear To Send (CTS)

2.1.5 Power Source

	<p>WARNING – Any installations involving electrical wiring and connections should be done by someone who is experienced in this field. The safety of any system incorporating the equipment, is the responsibility of the assembler of the system. Follow all local and national wiring codes.</p> <p>AVERTISSEMENT - Toute installation impliquant le câblage électrique et les connexions doivent être faites par quelqu'un qui est expérimenté dans ce domaine. La sécurité d'un système intégrant l'équipement, est de la responsabilité de l'assembleur du système. Suivre tous les codes de câblage local et national..</p>
--	---

The RAM-6021 router can be powered using:

- 4-pin screw terminal

Pin	Name	Description
1	GND	Ground
2	PWR+	Power supply input (8 to 30 VDC) (500mA@12VDC)
3	OUT	Digital output
4	IN	Digital and analog input

- Side mounted 2.5mm barrel connector (sleeve = ground, barrel = +power).



WARNING – DC 2.5mm Barrel Connector shall not be used in hazardous locations.
AVERTISSEMENT - Connecteur 2.5mm DC ne doit pas être utilisé dans des endroits dangereux.

2.1.6 Powering the Router

The RAM-6021 router will power up as soon as an 8 to 30 VDC voltage is applied to one of its power inputs and shuts off when this input voltage is below 4 VDC.

Note: To meet UL requirements, a “Class 2 Source” power supply is required. Terminals are sized to hold 28 to 12 gauge wire, 12 AWG wire area is 3.31mm². Torque spec for terminals is 0.5 Nm. Use copper wire rated to 90°C or above.

2.1.7 Testing the Power Connection

Check the PWR indicator light on the router: if it is turned on then the router is powered. If it's off, then review the installation procedures, or contact Red Lion Technical Support for further assistance.

2.2 Mounting the RAM-6021M12 Wired Router

There are two ways to mount a RAM-6021M12 wired router:

- Bulkhead mount
- Optional DIN-Rail mounting.

Note: Allow enough room to route the Ethernet, serial, I/O and other cables.

2.2.1 RAM-6021M12 Bulkhead Mounting & Removal

Use the following mechanical dimensions and drill hole placements drawing to bulkhead mount the RAM-6021M12 wired router.

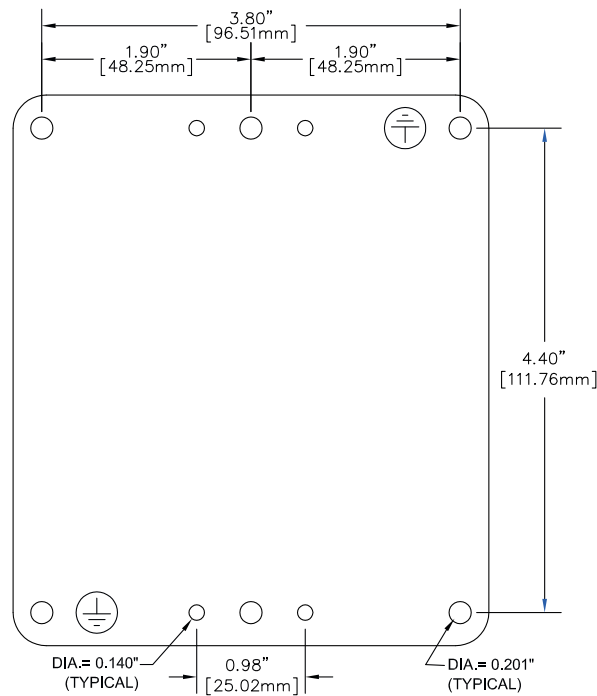

2.2.2 Ethernet Cable

If you are connecting to the router via 10Base-T ports, you will need a CAT 3 (or greater) twisted pair cable into the M12 connector.

If you are connecting to the router via 100Base-T ports, you will need a CAT 5 (or greater) twisted pair cable into the M12 connector.

Connect the other end to the far end station.

Note: To visually confirm that Ethernet cabling was done properly, verify the LINK LED's on the wired router are ON after completing the connection. The Link LED should be on when the right cable is used.

Use a standard CAT5 straight through or crossover cable To connect any other port to another switch or repeater.

Note: A shielded cable is required to fully meet EMC standards.

2.2.3 USB Cable

This is an Ethernet-over-USB connection which behaves like an Ethernet connection. It can only be connected to a PC with Windows 7/8 and any other Windows operating system. If you are connecting to the router via the USB port, you will need a NPSM5001 Plug M12 Male mini-b USB to an A Plug cable. In order for the USB connection to work, you need to install the Sixnet USB driver which is available at www.redlion.net.

Note: With firmware version 4.17 and later, standard Windows RNDS drivers are used and no additional driver is required from www.redlion.net.

2.2.4 I/O Cable

The RAM-6021M12 router I/O port uses an 8-pin A-Coded connector cable with pins 4, 5 and 6 used for Analog/Digital input and output.

2.2.5 Serial Cable

The RAM-6021M12 router Serial port uses a 5-pin serial communication over an 8-pin A-Coded connector.

The router is a DCE device, so use a straight-through serial cable between the router and a DTE device such as a terminal. Use a NULL router cable adapter between the router and a DCE device such as another router.

If using custom wiring or if some pins are disabled, follow the guidelines below. The wiring will vary depending on whether the attached serial device is a DTE or DCE.

PIN	NAME	DESCRIPTION
1	GND	Signal ground
2	SERIAL_RX	Serial receive input
3	SERIAL_TX	Serial transmit output
4	DIGITAL_OUT	Digital transmit output
5	DIGITAL_IN/ANALOG_IN	Digital receive input, Analog receive input
6	GND	Signal ground
7	SERIAL_RTS	Serial Request to Send
8	SERIAL_CTS	Serial Clear To Send

2.2.6 Power Source

	<p>WARNING – Any installations involving electrical wiring and connections should be done by someone who is experienced in this field. The safety of any system incorporating the equipment, is the responsibility of the assembler of the system. Follow all local and national wiring codes.</p> <p>AVERTISSEMENT - Toute installation impliquant le câblage électrique et les connexions doivent être faites par quelqu'un qui est expérimenté dans ce domaine. La sécurité d'un système intégrant l'équipement, est de la responsabilité de l'assembleur du système. Suivre tous les codes de câblage local et national..</p>
---	---

The RAM-6021M12 router is powered using a:

- M12 5-pin A-code connector

PIN	DESCRIPTION	NAME
1	Voltage 1+	V1+
2	Voltage 1-	V1-
3	Voltage 2 -	V2-
4	Voltage 2+	V2+
5	Case Ground	Case Ground

2.2.7 Powering the Router

The RAM-6021M12 router will power up as soon as an 8 to 49 VDC voltage is applied to one of its power inputs and shuts off when this input voltage is below 6.6 VDC.

2.2.8 Testing the Power Connection

Check the PWR indicator light on the router: if it is turned on then the router is powered. If it's off, then review the installation procedures, or contact Red Lion Technical Support for further assistance.

Service and Support Information

3.1 Service Information

We sincerely hope that you never experience a problem with any Red Lion product. If you do need service, call Red Lion at 1-877-432-9908 for Technical Support. A trained specialist will help you quickly determine the source of the problem. Many problems are easily resolved with a single phone call. If it is necessary to return a unit to us, an RO (Repair Order) can be obtained on the [Red Lion website](#).

Red Lion tracks the flow of returned material with our RO system to ensure speedy service. You must include this RO number on the outside of the box so that your return can be processed immediately.

Be sure to have your original purchase order number and date purchased available.

We suggest that you give us a repair purchase order number in case the repair is not covered under our warranty. You will not be billed if the repair is covered under warranty.

Please supply us with as many details about the problem as you can. The information you supply will be written on the RO form and supplied to the repair department before your unit arrives. This helps us to provide you with the best service, in the fastest manner. Repairs are completed as soon as possible. If you need a quicker turnaround, ship the unit to us by air freight. We give priority service to equipment that arrives by overnight delivery.

We apologize for any inconvenience that the need for repair may cause you. We hope that our rapid service meets your needs. If you have any suggestions to help us improve our service, please give us a call. We appreciate your ideas and will respond to them.

For Your Convenience:

Please fill in the following and keep this manual with your Red Lion system for future reference:

P.O. #: _____ Date Purchased: _____

Purchased From: _____

3.2 Product Support

Technical Support:

Inside US: +1 877 432-9908
Outside US: +1 717 767-6511
E-mail: support@redlion.net

Customer Service:

Inside US: +1 877 432-9908
Outside US: +1 717 767-6511
E-mail: customer.service@redlion.net



Statement of Limited Warranty

(a) Red Lion Controls Inc. (the “Company”) warrants that all Products shall be free from defects in material and workmanship under normal use for the period of time provided in “Statement of Warranty Periods” (available at www.redlion.net) current at the time of shipment of the Products (the “Warranty Period”). **EXCEPT FOR THE ABOVE-STATED WARRANTY, COMPANY MAKES NO WARRANTY WHATSOEVER WITH RESPECT TO THE PRODUCTS, INCLUDING ANY (A) WARRANTY OF MERCHANTABILITY; (B) WARRANTY OF FITNESS FOR A PARTICULAR PURPOSE; OR (C) WARRANTY AGAINST INFRINGEMENT OF INTELLECTUAL PROPERTY RIGHTS OF A THIRD PARTY; WHETHER EXPRESS OR IMPLIED BY LAW, COURSE OF DEALING, COURSE OF PERFORMANCE, USAGE OF TRADE OR OTHERWISE.** Customer shall be responsible for determining that a Product is suitable for Customer’s use and that such use complies with any applicable local, state or federal law.

(b) The Company shall not be liable for a breach of the warranty set forth in paragraph (a) if (i) the defect is a result of Customer’s failure to store, install, commission or maintain the Product according to specifications; (ii) Customer alters or repairs such Product without the prior written consent of Company.

(c) Subject to paragraph (b), with respect to any such Product during the Warranty Period, Company shall, in its sole discretion, either (i) repair or replace the Product; or (ii) credit or refund the price of Product provided that, if Company so requests, Customer shall, at Company’s expense, return such Product to Company.

(d) **THE REMEDIES SET FORTH IN PARAGRAPH (c) SHALL BE THE CUSTOMER’S SOLE AND EXCLUSIVE REMEDY AND COMPANY’S ENTIRE LIABILITY FOR ANY BREACH OF THE LIMITED WARRANTY SET FORTH IN PARAGRAPH (a).**

