

Digital Multimeter

Model MN42

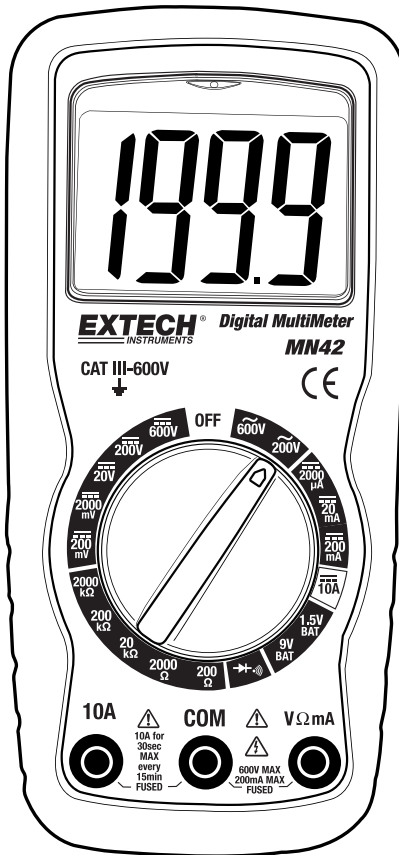

Introduction

Congratulations on your purchase of the Extech MN42 MultiMeter. The MN42 offers AC/DC Voltage, DC Current, and Resistance testing. Proper use and care of this meter will provide many years of reliable service.

Safety



WARNING

This symbol adjacent to another symbol, terminal or operating device indicates that the operator must refer to an explanation in the Operating Instructions to avoid personal injury or damage to the meter.

CAUTION

This **WARNING** symbol indicates a potentially hazardous situation, which if not avoided, could result in death or serious injury.

This **CAUTION** symbol indicates a potentially hazardous situation, which if not avoided, may result damage to the product.

**MAX
600V**

This symbol advises the user that the terminal(s) so marked must not be connected to a circuit point at which the voltage with respect to earth ground exceeds 600VAC or VDC.

This symbol adjacent to one or more terminals identifies them as being associated with ranges that may, in normal use, be subjected to particularly hazardous voltages. For maximum safety, the meter and its test leads should not be handled when these terminals are energized.

This symbol indicates that a device is protected throughout by double insulation or reinforced insulation.

SAFETY INSTRUCTIONS

This meter has been designed for safe use, but must be operated with caution. The rules listed below must be carefully followed for safe operation.

1. **NEVER** apply voltage or current to the meter that exceeds the specified maximum:

Input Protection Limits	
Function	Maximum Input
V DC or V AC	600V AC and DC 200Vrms on the 200mV range
mA DC	200mA DC 250V fast acting fuse
ADC	10A 250V fast acting fuse (30 seconds max every 15 minutes)
Resistance, Continuity	250Vrms 15 seconds max

2. **USE EXTREME CAUTION** when working with high voltages.
3. **DO NOT** measure voltage if the voltage on the "COM" input jack exceeds 500V above earth ground.
4. **NEVER** connect the meter leads across a voltage source while the function switch is in the current, resistance, or diode mode. Doing so can damage the meter.
5. **ALWAYS** discharge filter capacitors in power supplies and disconnect the power when making resistance or diode tests.
6. **ALWAYS** turn off power and disconnect test leads before opening the covers to replace the fuse or battery.
7. **NEVER** operate the meter unless the back cover and the battery and fuse covers are in place and fastened securely.
8. If the equipment is used in a manner not specified by the manufacturer, the protection provided by the equipment may be impaired.

Controls and Jacks

1. Non-Contact Voltage Sensor
2. LCD Display
3. Function switch
4. Positive jack
5. COM jack
6. 10A jack

Note: Tilt stand, fuse, and battery compartment are on rear of unit.

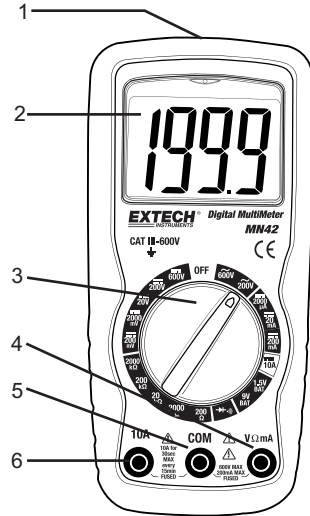

Symbols

- | | |
|------|--------------------------|
| •))) | Continuity |
| ▶ | Diode |
| μ | micro (amps) |
| m | milli (volts, amps) |
| k | kilo (ohms) |
| Ω | Ohms |
| ~ | Alternating (AC) current |
| --- | Direct (DC) current |
| BAT | Battery test |
| + | Low battery icon |

Operating Instructions

NON-CONTACT VOLTAGE (NCV)

WARNING: Always test the NCV function on a know live circuit before use

1. Turn the rotary switch to any measurement position
2. Hold the top of the meter very close to the voltage source as shown.
3. If voltage is present, the LED above the display will glow and the meter will buzz.

NOTE: The detector is designed with high sensitivity. Static electricity or other sources of energy may randomly trip the sensor. This is normal operation.



AC VOLTAGE MEASUREMENTS

WARNING: Risk of Electrocution. The probe tips may not be long enough to contact the live parts inside some 240V outlets for appliances because the contacts are recessed deep in the outlets. As a result, the reading may show 0 volts when the outlet actually has voltage on it. Make sure the probe tips are touching the metal contacts inside the outlet before assuming that no voltage is present.

CAUTION: Do not measure AC voltages if a motor on the circuit is being switched ON or OFF. Large voltage surges may occur that can damage the meter.

1. Set the function switch to the highest VAC position.
2. Insert the black test lead banana plug into the negative COM jack. Insert red test lead banana plug into the positive V jack.
3. Touch the black test probe tip to the negative side of the circuit. Touch the red test probe tip to the positive side of circuit.
4. Read the voltage in the display.



DC VOLTAGE MEASUREMENTS

CAUTION: Do not measure DC voltages if a motor on the circuit is being switched ON or OFF. Large voltage surges may occur that can damage the meter.

1. Set the function switch to the highest VDC position.
2. Insert the black test lead banana plug into the negative **COM** jack. Insert the red test lead banana plug into the positive **V** jack.
3. Touch the black test probe tip to the negative side of the circuit. Touch the red test probe tip to the positive side of the circuit.
4. Read the voltage in the display. Move the function switch to successively lower VDC positions to obtain a higher resolution reading. The display will indicate proper decimal point and value. If the polarity is reversed, the display will show (-) minus before the value.

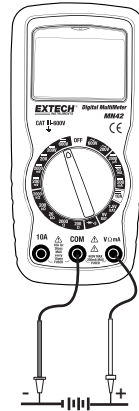

DC CURRENT MEASUREMENTS

CAUTION: Do not make current measurements at 10 Amps for longer than 30 seconds. Exceeding 30 seconds may cause damage to the meter and/or the test leads.

1. Insert the black test lead banana plug into the negative **COM** jack.
2. For current measurements up to 200mA DC, set the function switch to the highest mADC position and insert the red test lead banana plug into the **mA** jack.
3. For current measurements up to 10A DC, set the function switch to the 10A DC range and insert the red test lead banana plug into the **10A** jack.
4. Remove power from the circuit under test, then open up the circuit at the point where you wish to measure current.
5. Touch the black test probe tip to the negative side of the circuit. Touch the red test probe tip to the positive side of the circuit.
6. Apply power to the circuit.
7. Read the current in the display. For mADC measurements, reset the function switch to successively lower mADC positions to obtain a higher resolution reading.

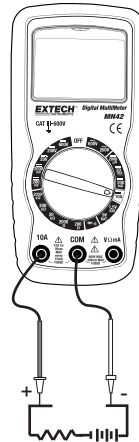

RESISTANCE MEASUREMENTS

WARNING: To avoid electric shock, disconnect power to the unit under test and discharge all capacitors before taking any resistance measurements.

1. Set the function switch to the highest Ω position.
2. Insert the black test lead banana plug into the negative **COM** jack.
Insert the red test lead banana plug into the positive Ω jack.
3. Touch the test probe tips across the circuit or part under test. It is best to disconnect one side of the part under test so the rest of the circuit will not interfere with the resistance reading.
4. Read the resistance in the display. Move the function switch to the lowest Ω position that is greater than the anticipated resistance.



CONTINUITY CHECK

WARNING: To avoid electric shock, never measure continuity on circuits that have a voltage potential.

1. Set the function switch to the  position.
2. Insert the black lead banana plug into the negative **COM** jack.
Insert the red test lead banana plug into the positive Ω jack.
3. Touch the test probe tips to the circuit or wire you wish to check.
4. If the resistance is less than approximately 30Ω , the audible signal will sound. If the circuit is open, the display will indicate "1".



DIODE TEST

1. Set the function switch to the $\rightarrow \rightarrow$ position.
2. Insert the black test lead banana plug into the negative **COM** jack and the red test lead banana plug into the positive \rightarrow jack.
3. Touch the test probes to the diode under test.
4. Forward voltage will indicate 400 to 700mV. Reverse voltage will indicate "1".
5. A shorted diode will indicate the same value of resistance in both the reverse and forward test directions. Shorted diodes will indicate near 0mV. An open diode will indicate "1" in both test directions.

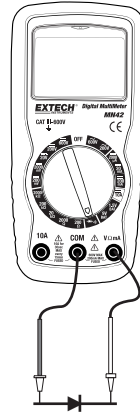

BATTERY TEST

CAUTION: Do not measure batteries while they are installed in the devices they are powering. The batteries must be removed from installations before tests can be made.

1. Set the function switch to the **1.5V** or **9V BAT** switch position. Use the 1.5V position for 'AAA', 'AA', 'C', 'D', and other 1.5V batteries. Use the 9V position for square 9V transistor batteries.
2. Insert the black test lead banana plug into the negative **COM** jack. Insert the red test lead banana plug into the positive **V** jack.
3. Touch the black test probe tip to the negative side of the battery. Touch the red test probe tip to the positive side of the battery.
4. Read the voltage in the display.

	Good	Weak	Bad
9V battery	>8.2V	7.2 to 8.2V	<7.2V
1.5V battery	>1.35V	1.22 to 1.35V	<1.22V



Maintenance

WARNING: To avoid electric shock, disconnect the test leads from any source of voltage before removing the back cover or the battery or fuse covers.

WARNING: To avoid electric shock, do not operate your meter until the battery and fuse covers are in place and fastened securely.

This MultiMeter is designed to provide years of dependable service, if the following care instructions are performed:

1. **KEEP THE METER DRY.** If it gets wet, wipe it off.
2. **USE AND STORE THE METER IN NORMAL TEMPERATURES.** Temperature extremes can shorten the life of the electronic parts and distort or melt plastic parts.
3. **HANDLE THE METER GENTLY AND CAREFULLY.** Dropping it can damage the electronic parts or the case.
4. **KEEP THE METER CLEAN.** Wipe the case occasionally with a damp cloth. **DO NOT** use chemicals, cleaning solvents, or detergents.
5. **USE ONLY FRESH BATTERIES OF THE RECOMMENDED SIZE AND TYPE.** Remove old or weak batteries so they do not leak and damage the unit.
6. **IF THE METER IS TO BE STORED FOR A LONG PERIOD OF TIME,** the battery should be removed to prevent damage to the unit.

BATTERY INSTALLATION and LOW BATTERY INDICATION

LOW BATTERY INDICATION

The  icon will appear in the display when the battery voltage becomes low. Replace the batteries when this appears.

BATTERY REPLACEMENT

1. Disconnect the test leads from the meter.
2. Remove the Phillips head screws (2) which secure the rear battery compartment cover.
3. Remove the fuse/battery compartment cover to access the battery.
4. Replace the 9V battery, observing polarity.
5. Replace and secure the fuse/battery compartment cover .

You, as the end user, are legally bound (**Battery ordinance**) to return all used batteries and accumulators; **disposal in the household garbage is prohibited!**

You can hand over your used batteries / accumulators at collection points in your community or wherever batteries / accumulators are sold!



Disposal: Follow the valid legal stipulations in respect of the disposal of the device at the end of its lifecycle

REPLACING THE FUSES

1. Disconnect the test leads from the meter.
2. Remove the Phillips head screws (2) which secure the rear battery compartment cover.
3. Remove the fuse/battery compartment cover to access the fuses.
4. Gently remove the fuse(s) and install new fuse(s) into the holder(s).
5. Always use fuses of the proper size and value (0.2A/250V fast blow for the 200mA range, 10A/250V fast blow for the 10A range). Both are 5x20mm in size.
6. Replace and secure the fuse/battery compartment cover .

Range Specifications

Function	Range	Resolution	Accuracy
DC Voltage (V DC)	200mV	0.1mV	±(0.5% reading + 2 digits)
	2000mV	1mV	
	20V	0.01V	
	200V	0.1V	±(0.8% reading + 2 digits)
	600V	1V	
AC Voltage (VAC) 50/60Hz	200V	0.1V	±(1.2% reading + 10 digits)
	600V	1V	±(2.0% reading + 4 digits)
DC Current (A DC)	2000μA	1μA	±(1.0% reading + 2 digits)
	20mA	10μA	
	200mA	100μA	±(1.5% reading + 2 digits)
	10A	10mA	±(2.0% reading + 2 digits)
Resistance	200Ω	0.1Ω	±(0.8% reading + 2 digits)
	2000Ω	1Ω	
	20kΩ	0.01kΩ	
	200kΩ	0.1kΩ	±(1.0% reading + 2 digits)
	2000kΩ	1kΩ	
Battery Test	9V	10mV	±(1.0% reading + 2 digits)
	1.5V	10mV	

Notes:

Accuracy specifications consist of two elements:

- (% reading) – This is the accuracy of the measurement circuit.
- (+ digits) – This is the accuracy of the analog to digital converter.

Accuracy is stated at 65°F to 83°F (18°C to 28°C) and less than 75% RH.

General Specifications

Diode Test	Test current of 1mA max, open circuit voltage 2.8VDC typical.
Continuity Check	Audible signal will sound if the resistance is less than 30 Ω
Batter Test current	9V (6mA); 1.5V (100mA)
Input Impedance	>1M Ω
ACV Bandwidth	45Hz to 450Hz
DCA voltage drop	200mV
NCV voltage range	100VAC to 600VAC
Display	3 ½ digit, 2000 count LCD, 0.5" digits
Overrange indication	"1" is displayed
Polarity	Automatic (no indication for positive); Minus (-) sign for negative
Measurement Rate	2 times per second, nominal
Low Battery Indication	 is displayed if battery voltage drops below operating voltage
Battery	One (1) 9V battery
Fuses	mA, μ A ranges; 0.2A/250V fast blow (5x20mm) A range; 10A/250V fast blow (5x20mm)
Operating Temperature	0°C to 50°C (32°F to 122°F)
Storage Temperature	-20°C to 60°C (-4°F to 140°F)
Operating Humidity	<70% RH
Storage Humidity	< 80% RH
Operating Altitude	2000 meters (7000 ft.) maximum.
Weight	255g(9 oz)
Size	150 x 70 x 48mm (5.9" x 2.75" x 1.8")
Safety	This meter is intended for indoor use and in accordance with Overvoltage Category III-600V, Pollution Degree 2.

PER IEC1010 OVERVOLTAGE INSTALLATION CATEGORY

OVERVOLTAGE CATEGORY I

Equipment of OVERVOLTAGE CATEGORY I is equipment for connection to circuits in which measures are taken to limit the transient overvoltages to an appropriate low level. Note – Examples include protected electronic circuits.

OVERVOLTAGE CATEGORY II

Equipment of OVERVOLTAGE CATEGORY II is energy-consuming equipment to be supplied from the fixed installation.

Note – Examples include household, office, and laboratory appliances.

OVERVOLTAGE CATEGORY III

Equipment of OVERVOLTAGE CATEGORY III is equipment in fixed installations.

Note – Examples include switches in the fixed installation and some equipment for industrial use with permanent connection to the fixed installation.

OVERVOLTAGE CATEGORY IV

Equipment of OVERVOLTAGE CATEGORY IV is for use at the origin of the installation.

Note – Examples include electricity meters and primary over-current protection equipment

Copyright © 2013 - 2015 FLIR Systems, Inc.

All rights reserved including the right of reproduction in whole or in part in any form

ISO-9001 Certified

www.extech.com