

Type 2101

2/2-way globe valve

2/2-Wege-Geradsitzventil

Vanne à siège droit 2/2 voies

Operating Instructions

Bedienungsanleitung

Manuel d'utilisation



We reserve the right to make technical changes without notice.
Technische Änderungen vorbehalten.
Sous réserve de modifications techniques.

© Bürkert Werke GmbH & Co. KG, 2008 - 2017

Operating Instructions 1703/08_EU-ML_00806076 / Original DE

1	OPERATING INSTRUCTIONS	4	8	INSTALLATION	17
1.1	Symbols.....	4	8.1	Safety instructions.....	17
1.2	Definition of term / abbreviation.....	4	8.2	Before installation.....	18
2	AUTHORIZED USE	5	8.3	Installation.....	19
2.1	Restrictions.....	5	8.4	Pneumatic connection.....	21
3	BASIC SAFETY INSTRUCTIONS	5	8.5	Start-up.....	22
4	GENERAL INFORMATION	6	8.6	Removal.....	23
4.1	Contact address.....	6	9	ELECTRICAL CONTROL UNIT	23
4.2	Warranty.....	6	10	MAINTENANCE, CLEANING	24
4.3	Information on the Internet.....	6	10.1	Safety instructions.....	24
5	PRODUCT DESCRIPTION	7	10.2	Maintenance work.....	24
5.1	General description.....	7	10.3	Replacing the wearing parts.....	25
5.2	Versions.....	7	11	MALFUNCTIONS	33
5.3	Properties.....	7	12	REPLACEMENT PARTS	34
5.4	Designated application area.....	8	12.1	Replacement part sets.....	34
6	STRUCTURE AND FUNCTION	8	12.2	Installation tools.....	35
6.1	Structure.....	8	13	PACKAGING, TRANSPORT, STORAGE	36
6.2	Function.....	9			
7	TECHNICAL DATA	11			
7.1	Conformity.....	11			
7.2	Standards.....	11			
7.3	Type label.....	11			
7.4	Operating conditions.....	12			
7.5	General technical data.....	16			

1 OPERATING INSTRUCTIONS

The operating instructions describes the entire life cycle of the device. Keep these instructions in a location which is easily accessible to every user, and make these instructions available to every new owner of the device.



WARNING!

The operating instructions contain important safety information!

Failure to observe these instructions may result in hazardous situations.

- ▶ The operating instructions must be read and understood.

1.1 Symbols



DANGER!

Warns of an immediate danger!

- ▶ Failure to observe the warning may result in a fatal or serious injury.



WARNING!

Warns of a potentially dangerous situation!

- ▶ Failure to observe the warning may result in serious injuries or death.



CAUTION!

Warns of a possible danger!

- ▶ Failure to observe this warning may result in a moderate or minor injury.

NOTE!

Warns of damage to property!

- ▶ Failure to observe the warning may result in damage to the device or the equipment.



Indicates important additional information, tips and recommendations.



Refers to information in these operating instructions or in other documentation.

- ▶ designates instructions for risk prevention.

→ Designates a procedure which you must carry out.

1.2 Definition of term / abbreviation

The term "device" used in these instructions always stands for the globe valve Type 2101.

The abbreviation "Ex" used in these instructions always stands for "explosion-protected".

2 AUTHORIZED USE

Non-authorized use of the globe valve Type 2101 may be a hazard to people, nearby equipment and the environment.

- ▶ The device is designed for the controlled flow of liquid and gaseous media.
- ▶ In the potentially explosion-risk area the globe valve Type 2101 may be used only according to the specification on the separate Ex type label. For use observe the additional information enclosed with the device together with safety instructions for the explosion-risk area.
- ▶ Devices without a separate Ex type label may not be used in a potentially explosive area.
- ▶ The admissible data, the operating conditions and conditions of use specified in the contract documents, operating instructions and on the type label are to be observed during use. These are described in the chapter entitled ["5 Product description"](#).
- ▶ The device may be used only in conjunction with third-party devices and components recommended and authorized by Bürkert.
- ▶ Correct transportation, correct storage and installation and careful use and maintenance are essential for reliable and fault-less operation.
- ▶ Use the device only as intended.

2.1 Restrictions

If exporting the system or device, observe any existing restrictions.

3 BASIC SAFETY INSTRUCTIONS

These safety instructions do not make allowance for any

- contingencies and events which may arise during the installation, operation and maintenance of the devices.
- local safety regulations, whereby the operator is responsible for their compliance, by the installation personnel too.



DANGER!

Danger – high pressure!

- ▶ Before dismantling the lines and valves, turn off the pressure and vent the lines.

Risk of electric shock!

- ▶ Before reaching into the device, switch off the power supply and secure to prevent reactivation!
- ▶ Observe applicable accident prevention and safety regulations for electrical equipment!



WARNING!

Risk of injury when opening the actuator!

The actuator contains a tensioned spring. If the actuator is opened, there is a risk of injury from the spring jumping out!

- ▶ The actuator must not be opened.

Risk of injury from moving parts in the device!

- ▶ Do not reach into openings.



CAUTION!

Risk of burns!

The surface of the device may become hot during long-term operation.

- ▶ Do not touch the device with bare hands.

General hazardous situations.

To prevent injury, ensure:

- ▶ That the system cannot be activated unintentionally.
- ▶ Installation and repair work may be carried out by authorized technicians only and with the appropriate tools.
- ▶ After an interruption in the power supply or pneumatic supply, ensure that the process is restarted in a defined or controlled manner.
- ▶ The device may be operated only when in perfect condition and in consideration of the operating instructions.
- ▶ The general rules of technology apply to application planning and operation of the device.

To prevent damage to property of the device, ensure:

- Supply the media connections only with those media which are specified as flow media in the chapter entitled "[7 Technical data](#)".
- Do not put any loads on the valve (e.g. by placing objects on it or standing on it).
- Do not make any external modifications to the valves. Do not paint the body parts or screws.

4 GENERAL INFORMATION

4.1 Contact address

Germany

Bürkert Fluid Control Systems
Sales Center
Chr.-Bürkert-Str. 13-17
D-74653 Ingelfingen
Tel. : 07940 - 10 91 111
Fax: 07940 - 10 91 448
E-mail: info@buerkert.com

International

Contact addresses are found on the final pages of the printed operating manual.

You can also find information on the Internet under:

www.burkert.com

4.2 Warranty

The warranty is only valid if the device is used as authorized in accordance with the specified application conditions.

4.3 Information on the Internet

The operating instructions and data sheets for Type 2101 can be found on the Internet at: www.burkert.com

5 PRODUCT DESCRIPTION

5.1 General description

The 2/2-way globe valve Type 2101 is suitable for liquid and gaseous media.

It uses neutral gases or air (control media) to control the flow of water, alcohol, oil, fuel, hydraulic fluid, saline solution, lye, organic solvent and steam (flow media).

A special feature of globe valves are screwed-in seats which can be used to reduce the orifice of the control valve in particular.



According to the general understanding of Bürkert, DN designates the orifice of the seat, not the orifice of the line connection.

5.2 Versions

There are 2 versions of the globe valve type 2101:

- Standard version – **without** separate Ex type label.
The standard version must not be used in the potentially explosive area.
- Ex version – **with** separate Ex type label.
The Ex version may be used in the potentially explosive area. In doing so, observe the specifications on the separate Ex type label and the additional information enclosed with the device together with safety instructions for the Ex area.

5.3 Properties

- High tightness by self-adjusting packing glands (spindle sealing element).
- High seat tightness by swivel plate.
- Actuator can be rotated steplessly through 360 °.
- Maintenance-free under normal conditions.

5.3.1 Options

- Control unit
Different versions of the control units are available depending on the requirement.
- Stroke limitation
Limit of the maximum open position /flow rate by means of adjusting screw.
- Feedback indicator
The device features mechanical limit switches or inductive proximity switches.

5.3.2 Device versions

The globe valve is available for the following actuator sizes:

ø 50 mm, ø 70 mm, ø 90 mm, ø 130 mm.

5.3.3 Restrictions



WARNING!

Risk of injury from water hammer.

A water hammer could crack the lines and device.

Due to the risk of water hammer, **valves with a flow direction above seat must not be used for liquid media.**

- ▶ Consider the type of flow direction and the type of medium for operation of the device.

5.4 Designated application area



Observe the maximum pressure range according to the type label!

- Neutral gases and liquids up to 16 bar.
- Steam up to 11 bar absolute / 185 °C.
- Aggressive media.

5.4.1 Application areas

- e.g.
- Plant construction
 - Food processing
 - Chemical engineering
 - Sterilizer construction

6 STRUCTURE AND FUNCTION

6.1 Structure

The globe valve consists of a pneumatically actuated piston actuator and a 2/2-way valve body.

The actuator is manufactured from polyphenylene sulphide (PPS). The tried and tested, self-adjusting packing gland ensures high tightness. The flow-enhancing valve body made of stainless steel enables high flow values.

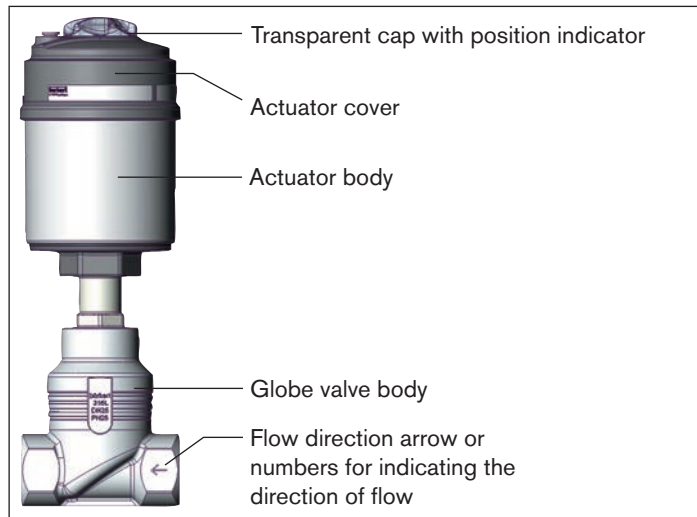

Fig. 1: Globe valve Type 2101, structure and description (1)



The description of the control function (CF) can be found in chapter entitled "[6.2.1 Control functions \(CF\)](#)".

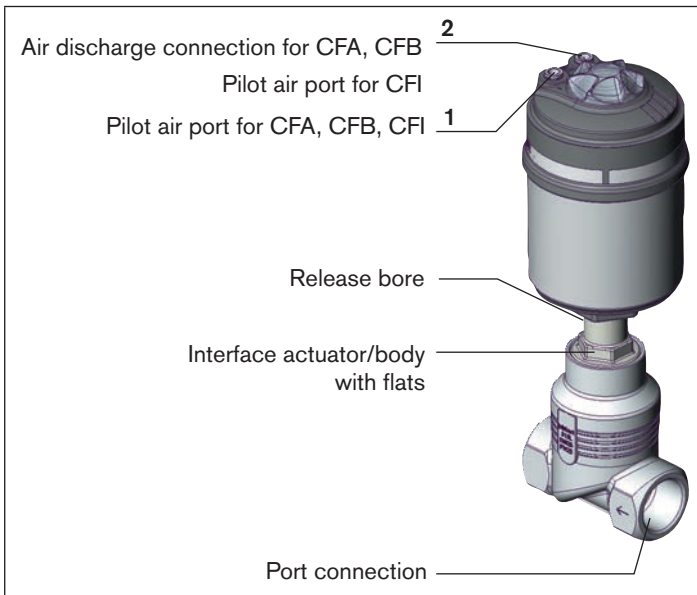

Fig. 2: Globe valve Type 2101, Structure and Description (2)

6.2 Function

Depending on the version, the seat of the valve is closed with or against the medium flow.

Spring force (CFA) or pneumatic pilot pressure (CFB and CFI) generates the closing force on the swivel plate. The force is transferred via a spindle which is connected to the actuator piston.

6.2.1 Control functions (CF)



WARNING!

For control function I – Danger if pilot pressure fails!

For control function I control and resetting occur pneumatically. If the pressure fails, no defined position is reached.

- ▶ To ensure a controlled restart, first pressurize the device with pilot pressure, then switch on the medium.

Control function A (CFA)

Normally closed by spring action

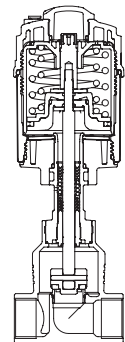
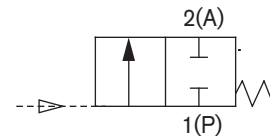

Control function B (CFB)

Normally open by spring action

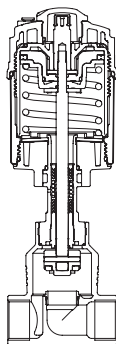
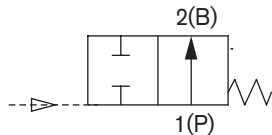

Control function I (CFI)

Actuating function via reciprocal pressurisation.

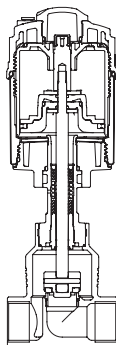
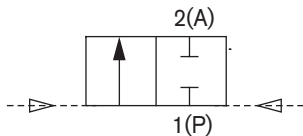

6.2.2 Flow direction below seat

Depending on the version, the valve is closed against the medium flow with spring force (control function A, CFA) or with pilot pressure (control function B or I, CFB or CFI).

As the medium pressure is under the swivel plate, this pressure contributes to the opening of the valve.



WARNING!

Medium may be discharged if minimum pilot pressure is too low or medium pressure too high!

If the minimum pilot pressure is too low for CFB and CFI or the permitted medium pressure is exceeded, leaks may occur.

- ▶ Observe minimum pilot pressure
- ▶ Do not exceed medium pressure.
- ▶ See chapter entitled "[7.4.1 Temperature ranges](#)".

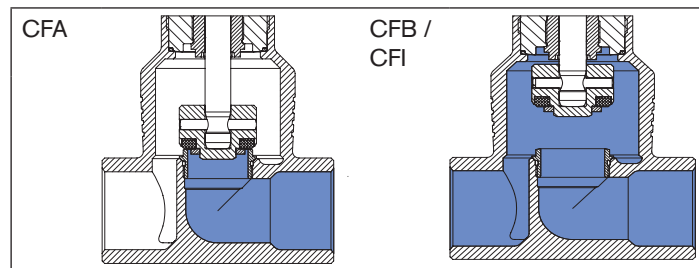

Fig. 3: Flow direction below seat
(Rest open/closed, closing against medium)

6.2.3 Flow direction above seat

The valve is closed by spring force (control function A, CFA) with the medium flow. As the medium pressure is over the swivel plate, it supports the closing process of the valve and also contributes to the sealing of the valve seat. The valve is opened by the pilot pressure.



WARNING!

Risk of injury from water hammer.

A water hammer could crack the lines and device.
Due to the risk of water hammer, **valves with a flow direction above seat must not be used for liquid media.**

- ▶ Consider the type of flow direction and the type of medium for operation of the device.



To ensure complete opening, the minimum pilot pressure must be used!

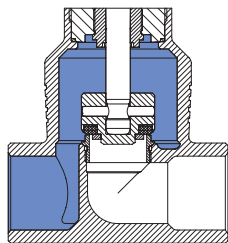

Fig. 4: Flow direction above seat (rest closed, closing with medium)

7 TECHNICAL DATA

7.1 Conformity

Type 2101 conforms with the EC Directives according to the EC Declaration of Conformity.

7.2 Standards

The applied standards, which verify conformity with the EC Directives, can be found on the EC-Type Examination Certificate and / or the EC Declaration of Conformity.

According to Pressure Equipment Directive the following operating conditions must be observed:

Line connection orifice	Maximum pressure for compressible fluids of Group 1 (hazardous gases and vapors according to Art. 3 No. 1.3 Letter a first dash)
DN65	15 bar

7.3 Type label

Example:

bürkert 2101 A 32M PTFE VA Pilot 4,8-10bar
 Made in Germany Tmed -10°C - +185°C Pmed 8,5bar
 00218445 Flow 1 ← 2 Da=42,4 s=2,0 Kv 19,5 W11MS



Fig. 5: Example of type label



WARNING!

Risk of injury from high pressure!

Important device-specific technical specifications are indicated on the type label.

- ▶ Observe permitted pressure range on the type label of the device.

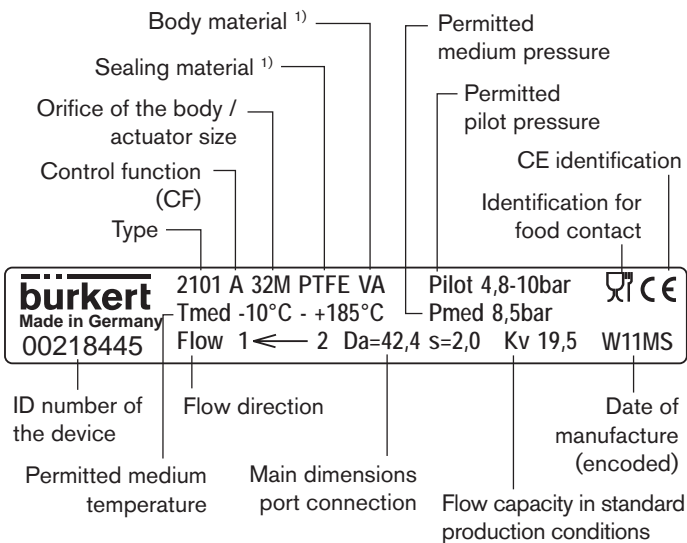

¹⁾ For a description of the versions see the following chapter entitled ["7.5 General technical data"](#).

7.4 Operating conditions

7.4.1 Temperature ranges

Actuator size	Actuator material	Medium (for PTFE seal)	Environment ²⁾
ø 50 mm	PPS	-10 – +185 °C	0 – +60 °C ³⁾ 0 – +100 °C ⁴⁾
ø 70 mm			
ø 90 mm			
ø 130 mm			

Tab. 1: Temperature Ranges



²⁾ If a pilot valve is used, the max. ambient temperature is +55 °C.



The globe valve is suitable for steam sterilization.

³⁾ Pilot air ports with push-in connector

⁴⁾ Pilot air ports with threaded bushing

7.4.2 Pressure ranges

Actuator size	Maximum pilot pressure ⁵⁾
ø 50 mm	10 bar
ø 70 mm	
ø 90 mm	
ø 130 mm	7 bar

Tab. 2: Pressure Ranges



⁵⁾ For the device version ø 70 / Orifice 50 / MC 13 the maximum permitted pilot pressure is limited to 7 bar.

Medium and pilot pressure for control function A, flow direction below the seat (standard)

Orifice DN	Maximum medium pressure [bar]				Minimum pilot pressure [bar]			
	Actuator size ø [mm]				Actuator size ø [mm]			
	50	70	90	130	50	70	90	130
10/15	25	25	-	-	5.2	4.8	-	-
20	16	20						
25	9	16						
32	-	8.5	16	-	-	5	5	
40		6	16					
50		4	10					16
65		5.0	16 (15*)					
80		-	-					10
100		-	-					6
		-	-					-

Tab. 3: Medium and pilot pressure for CFA, standard

* According to Pressure Equipment Directive for compressible fluids of Group 1 (hazardous gases and vapors according to Art. 3 No. 1.3 Letter a first dash)

Medium and pilot pressure for control function A, flow direction below the seat reduced pressure spring force (EC04)

Orifice DN	Maximum medium pressure [bar]				Minimum pilot pressure [bar]			
	Actuator size \varnothing [mm]				Actuator size \varnothing [mm]			
	50	70	90	130	50	70	90	130
10/15	14	16						
20	6	12	-	-	3.2		-	-
25	3	6				2.5		
32		3.5	9					
40		2	6	16			2.5	
50	-		3.5	10	-			2.5
65		-		7.5		-		
80			-	5			-	3.2

Tab. 4: Medium and pilot pressure for CFA, reduced pressure spring force (EC04)

Required minimum pilot pressure depending on medium pressure

The following graphs illustrate the required minimum pilot pressure depending on the medium pressure for control functions A, B and I.

Control function A, flow direction above seat

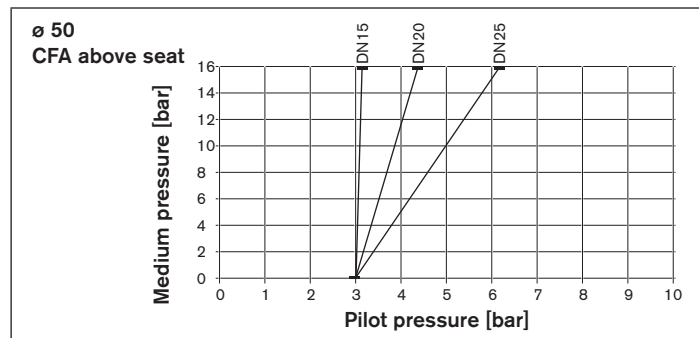

Fig. 6: Pressure graph, actuator \varnothing 50 mm, control function A, flow direction above seat

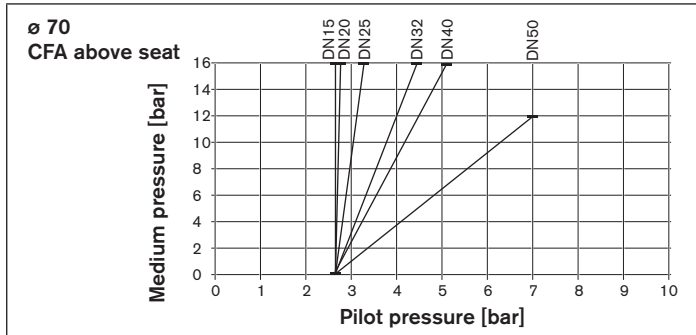

Fig. 7: Pressure graph, actuator \varnothing 70 mm, control function A, flow direction above seat

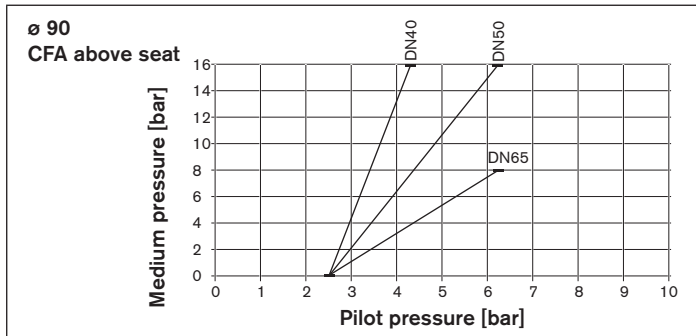

Fig. 8: Pressure graph, actuator \varnothing 90 mm, control function A, flow direction above seat

Control functions B and I, flow direction below seat

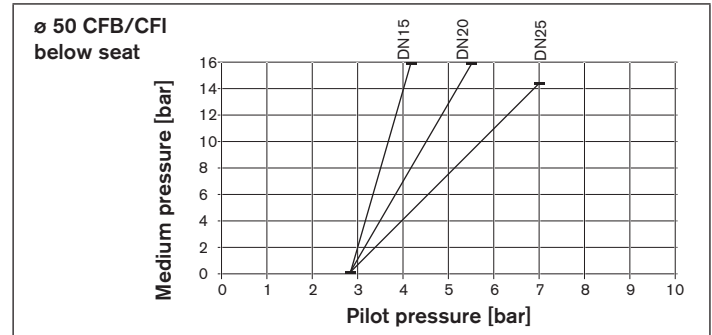

Fig. 9: Pressure graph, actuator \varnothing 50 mm, control functions B and I, flow direction below seat

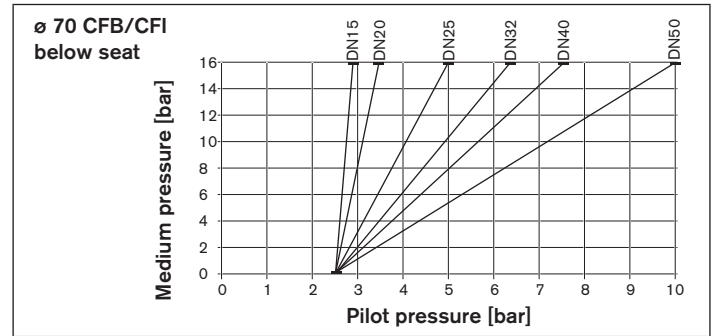

Fig. 10: Pressure graph, actuator \varnothing 70 mm, control functions B and I, flow direction below seat

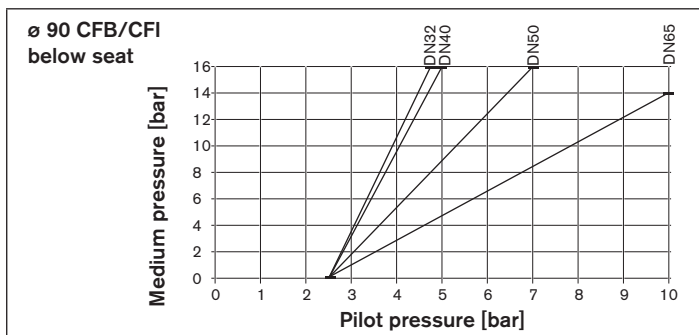

Fig. 11: Pressure graph, actuator ø 90 mm, control functions B and I, flow direction below seat

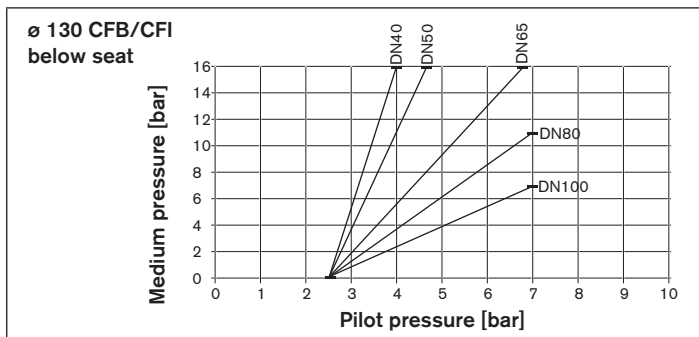

Fig. 12: Pressure graph, actuator ø 130 mm, control functions B and I, flow direction below seat

7.5 General technical data

Actuator size	see type label
Control function	see type label, description of control functions see chapter "6.2"
Installation	as required, preferably with actuator in upright position
Protection class	IP67 in accordance with IEC 529 / EN 60529

Media

Control medium	Neutral gases, air
Flow media	Water, alcohol, fuel, hydraulic liquids, saline solutions, lye, organic solvents

Materials

Body	316L
Actuator	PPS and stainless steel
Sealing elements	FKM and EPDM
Spindle sealing (with silicone grease)	PTFE V rings with spring compensation
Seat seal	PTFE (NBR, EPDM, FKM on request)
Swivel plate	
Spindle	1.4401 / 1.4404
Spindle guide	
DN10-65	PEEK
DN80-100	1.4401 / 1.4404

Connections

Pilot air port	Plug-in connector 6/4 mm or 1/4" others on request
Medium connection	Socket: G 1/2 – G 4 (NPT, RC on request) Weld end connection: in accordance with ISO 4200, DIN 11850 R2 other connections on request

8 INSTALLATION

8.1 Safety instructions



DANGER!

Risk of injury from high pressure!

- ▶ Before loosening the lines and valves, turn off the pressure and vent the lines.



WARNING!

Risk of injury from improper installation!

- ▶ Installation may be carried out by authorized technicians only and with the appropriate tools!

Risk of injury from unintentional activation of the system and an uncontrolled restart!

- ▶ Secure system from unintentional activation.
- ▶ Following installation, ensure a controlled restart.

For control function I – Danger if pilot pressure fails!

For control function I control and resetting occur pneumatically. If the pressure fails, no defined position is reached.

- ▶ To ensure a controlled restart, first pressurize the device with pilot pressure, then switch on the medium.

Risk of injury from moving parts in the device!

- ▶ Do not reach into openings.

8.2 Before installation

- The globe valve can be installed in any installation position, preferably with the actuator face up.
- Before connecting the valve, ensure the lines are flush.
- Observe direction of flow (see type label).

8.2.1 Preparatory work

→ Clean pipelines (sealing material, swarf, etc.).

Devices with welded body

NOTE!

For valves with installed control:

When welding the valve body into the pipeline, the control must not be installed.

- ▶ Remove control from the actuator (see installation chapter in the operating instructions for the corresponding control).

Remove the actuator from the valve body:

→ Clamp the valve body in a holding device.

NOTE!

Damage to the seat seal or the seat contour!

- ▶ When removing the actuator, ensure that the valve is in open position.

→ Control function A pressurize the pilot air port 1 with compressed air (5 bar): valve opens.

→ Using a suitable open-end wrench, place the wrench flat on the tube.

→ Unscrew the actuator from the valve body.

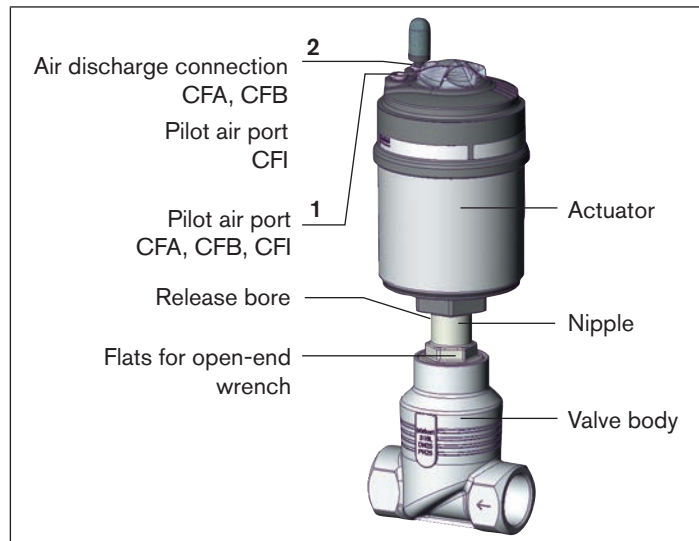

Fig. 13: Installation

Other device versions

→ Do not remove actuator unless this is a customer-specific requirement.

→ Procedure see [“Devices with welded body”](#).

8.3 Installation



WARNING!

Risk of injury from improper assembly!

Assembly with unsuitable tools or non-observance of the tightening torque is dangerous as the device may be damaged.

- ▶ For installation use an open-end wrench, never a pipe wrench.
- ▶ Observe the tightening torque (see ["Tab. 5: Tightening torques of valve body / nipples"](#)).

Dirt trap for devices with authorization in accordance with DIN EN 161

In accordance with DIN EN 161 "Automatic shut-off valves for gas burners and gas appliances" a dirt trap must be connected upstream of the valve and prevent the insertion of a 1 mm plug gauge.

- If the authorisation also applies to stainless steel bodies, the same type of dirt trap must be attached in front of the globe valve.

8.3.1 Installation of the valve body

Welded bodies

- Weld valve body in pipeline system.

Other body versions

- Connect body to pipeline.

8.3.2 Install actuator (welded body)

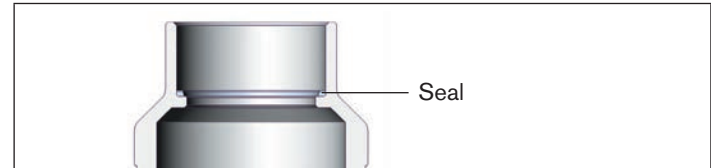

Fig. 14: Seal

- Check the seal and if required, replace it.



WARNING!

Danger if incorrect lubricants used!

Unsuitable lubricant may contaminate the medium. In oxygen applications there is a risk of an explosion!

- ▶ In specific applications, e.g. oxygen or analysis applications, use appropriately authorised lubricants only.

- Grease nipple thread before re-installing the actuator (e.g. with Klüber paste UH1 96-402 from Klüber).

NOTE!

Damage to the seat seal or the seat contour!

- ▶ When installing the actuator, ensure that the valve is in open position.

- Control function A pressurize the pilot air port 1 with compressed air (5 bar): valve opens.

- Screw actuator into the valve body.
Observe tightening torque (see “[Tab. 5: Tightening torques of valve body / nipples](#)”).

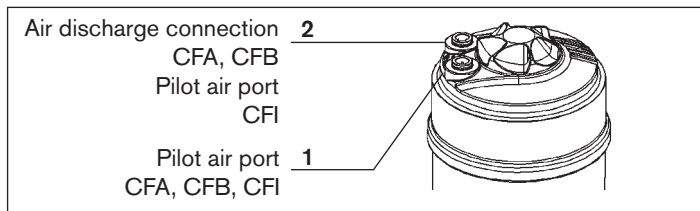

Fig. 15: Connections

Tightening torques of valve body / nipples	
DN	Tightening torque [Nm]
13/15	45 ± 3
20	50 ± 3
25	60 ± 3
32	65 ± 3
40	
50	70 ± 3
65	100 ± 3
80	120 ± 5
100	150 ± 5

Tab. 5: Tightening torques of valve body / nipples

8.3.3 Install control



Description see Installation chapter in the operating instructions for the corresponding control.

8.3.4 Rotating the actuator

The position of the connections can be aligned steplessly by rotating the actuator through 360°.

NOTE!

Damage to the seat seal or the seat contour!

- ▶ When rotating the actuator, ensure that the valve is in open position.

Procedure:

- Clamp the valve body in a holding device (applies only to valves which have not yet been installed).
- Control function A pressurize the pilot air port 1 with compressed air (5 bar): valve opens.
- Counter on the flats of the nipple with a suitable open-end wrench.
- Actuator with hexagon:
Place suitable open-end wrench on the hexagon of the actuator.
- Actuator without hexagon:
Fit special wrench⁶⁾ exactly to the underside of the actuator.

⁶⁾ The special key (identification number 665 702) is available from your Bürkert sales office.

! WARNING!

Risk of injury from discharge of medium and pressure!

If the direction of rotation is wrong, the body interface may become detached.

- ▶ Rotate the actuator module in the specified direction only (see “Fig. 16”)!

- Actuator with hexagon:
Rotate counter-clockwise (as seen from below) to bring the actuator module into the required position.
- Actuator without hexagon:
Rotate clockwise (as seen from below) to bring the actuator module into the required position.

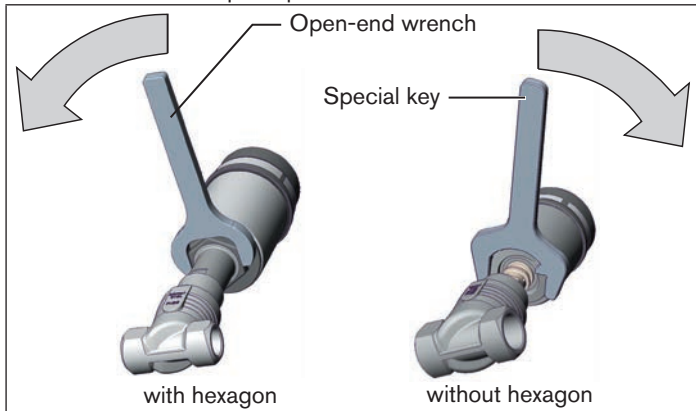

Fig. 16: Rotating with special key / open-end wrench

8.4 Pneumatic connection

! DANGER!

Danger – high pressure in the equipment!

- ▶ Before loosening the lines and valves, turn off the pressure and vent the lines.

! WARNING!

Risk of injury from unsuitable connection hoses!

Hoses which cannot withstand the pressure and temperature range may result in hazardous situations.

- ▶ Use only hoses which are authorised for the indicated pressure and temperature range.
- ▶ Observe the data sheet specifications from the hose manufacturers.

For control function I – Danger if pilot pressure fails!

For control function I control and resetting occur pneumatically. If the pressure fails, no defined position is reached.

- ▶ To ensure a controlled restart, first pressurize the device with pilot pressure, then switch on the medium.

8.4.1 Connection of the control medium



If the position of the pilot air ports for installation of the hoses is unfavorable, these can be aligned steplessly by rotating the actuator through 360°.

The procedure is described in the chapter entitled [“8.3.4 Rotating the actuator”](#).

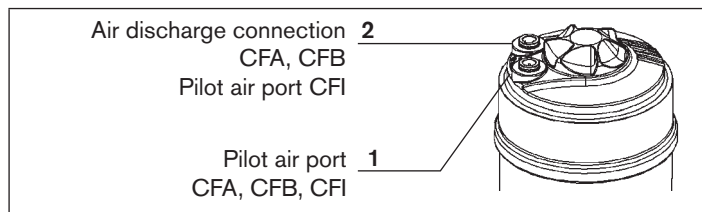

Fig. 17: Pneumatic connection

Control functions A and B:

→ Connect the control medium to the pilot air port 1 of the actuator (see [“Fig. 17”](#)).

Silencer

For the versions with a plug-in connection the silencer for reducing the exhaust air noise is supplied loose.

→ Plug the silencer into the free air discharge connection 2 (see [“Fig. 17”](#)).



If used in an aggressive environment, we recommend conveying all free pneumatic connections into a neutral atmosphere with the aid of a pneumatic hose.

Control function I:

→ Connect the control medium to the pilot air port 1 and 2 of the actuator (see [“Fig. 18: Pneumatic connection”](#))
Pressure on connection 1 opens the valve.
Pressure on connection 2 closes the valve.

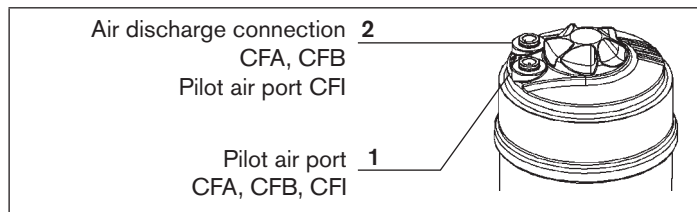

Fig. 18: Pneumatic connection

Control air hose:

6/4 mm or 1/4" control air hoses can be used.

Optionally a pilot air port is possible via a G 1/8 thread.

8.5 Start-up

After installing the device, run the teach function. This function presets the control parameters.



Description – see operating instructions for the control.

8.6 Removal



DANGER!

Risk of injury from discharge of medium and pressure!

It is dangerous to remove a device which is under pressure due to the sudden release of pressure or discharge of medium.

- ▶ Before removing a device, switch off the pressure and vent the lines.

Procedure:

- Loosen the pneumatic connection.
- Remove the device.

9 ELECTRICAL CONTROL UNIT

The valve Type 2101 can be combined with following control units:

- Type 8690 Pneumatic Control Unit
- Type 8691 Control head (actuator size \varnothing 70 - \varnothing 130)
- Type 8695 Control head (actuator size \varnothing 50)
- Type 8645 Automation system FreeLINE
- Type 6012 Pilot valve
- Type 6014 P Pilot valve



The electrical connection of the pilot valve or the control unit is described in the respective operating instructions for the pilot valve/control unit.

10 MAINTENANCE, CLEANING

10.1 Safety instructions



DANGER!

Danger – high pressure in the equipment!

- ▶ Before loosening the lines and valves, turn off the pressure and vent the lines.

Risk of injury due to electrical shock!

- ▶ Before reaching into the system, switch off the power supply and secure to prevent reactivation!
- ▶ Observe applicable accident prevention and safety regulations for electrical equipment!



WARNING!

Risk of injury from improper maintenance!

- ▶ Maintenance may be performed by authorised technicians only!
- ▶ To screw on or unscrew valve body or actuator, use an open-end wrench, never a pipe wrench, and observe tightening torques.

Risk of injury from unintentional activation of the system and an uncontrolled restart!

- ▶ Secure system from unintentional activation.
- ▶ Following maintenance, ensure a controlled restart.



WARNING!

For control function I – Danger if pilot pressure fails!

For control function I control and resetting occur pneumatically. If the pressure fails, no defined position is reached.

- ▶ To ensure a controlled restart, first pressurize the device with pilot pressure, then switch on the medium.

Risk of injury from moving parts in the device!

- ▶ Do not reach into openings.

10.2 Maintenance work

Actuator:

The actuator of the globe valve is maintenance-free provided it is used according to these operating instructions.

Wearing parts of the globe valve:

Parts which are subject to natural wear:

- Seals
- Swivel plate

→ If leaks occur, replace the particular wearing part with an appropriate spare part.
(For spare-part sets and installation tools see chapter entitled “12 Replacement parts”).



The replacing of the wearing parts is described in chapter “10.3 Replacing the wearing parts”.

Visual inspection:

Perform regular visual inspections according to the application conditions:

- Check media connections for leaks.
- Check release bore on the tube for leaks.

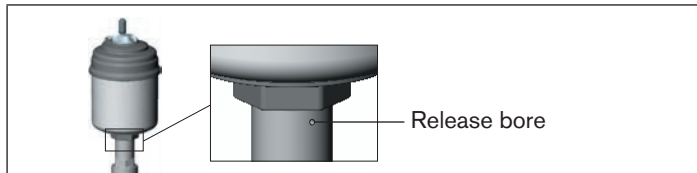

Fig. 19: Release bore

10.2.1 Cleaning

Commercially available cleaning agents can be used to clean the outside.

NOTE!

Avoid causing damage with cleaning agents.

- ▶ Before cleaning, check that the cleaning agents are compatible with the body materials and seals.

10.3 Replacing the wearing parts

10.3.1 Replacing the valve set

The valve set consists of

- Swivel plate
- Pin
- Seal

Before the valve set can be replaced, the actuator must be removed from the valve body.



DANGER!

Risk of injury from discharge of medium and pressure!

It is dangerous to remove a device which is under pressure due to the sudden release of pressure or discharge of medium.

- ▶ Before removing a device, switch off the pressure and vent the lines.



WARNING!

Risk of injury if the wrong tools are used!

It is dangerous to use unsuitable tools for installation work as the device may be damaged.

- ▶ To remove the actuator from the valve body, use an open-end wrench, never a pipe wrench.

Remove the actuator from the valve body:

- Clamp the valve body in a holding device (applies only to valves which have not yet been installed).

NOTE!

Damage to the seat seal or the seat contour!

- ▶ When removing the actuator, ensure that the valve is in open position.

- Control function A pressurize the pilot air port 1 with compressed air (5 bar): valve opens.
- Using a suitable open-end wrench, place the wrench flat on the tube.
- Unscrew the actuator from the valve body.

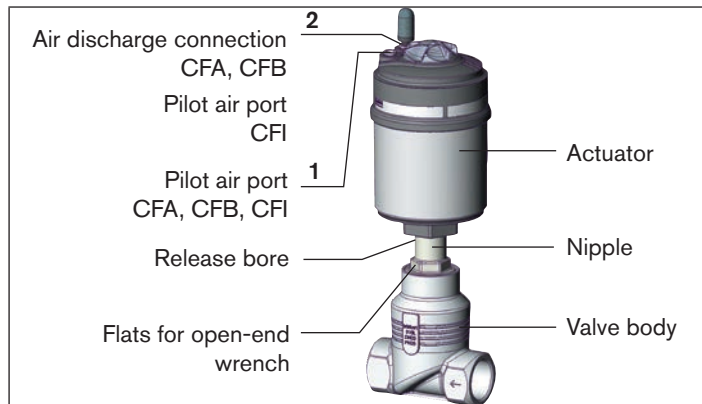

Fig. 20: Designation parts

Replacing valve set

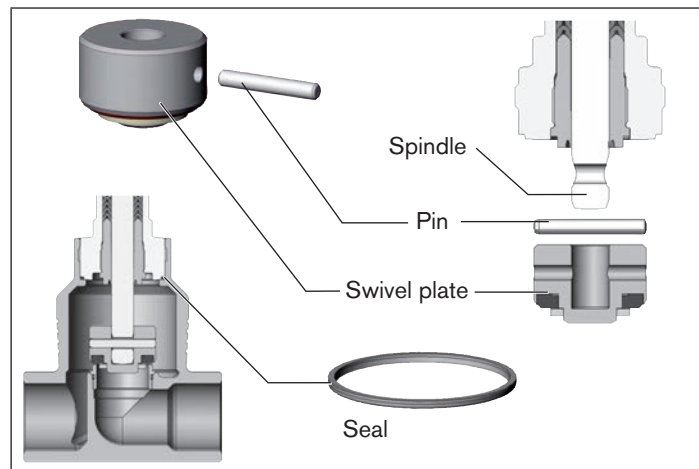

Fig. 21: Valve set

Procedure:

- Support swivel plate on the cylindrical part with the aid of a prism or something similar.
- Knock out pin with a suitable pin punch.
Pin punch \varnothing 3 mm, for spindle diameter 10 mm on the swivel plate.
Pin punch \varnothing 5 mm, for spindle diameter 14 mm on the swivel plate.
- Remove swivel plate.

- Connect new swivel plate to the spindle.
- Align bores of the swivel plate and spindle.
- Support swivel plate on the cylindrical part with the aid of a prism or something similar.
- Insert pin into the bore.
- Swage pin bores on both sides of the swivel plate using a chisel or center punch.

Installing the actuator on the valve body

- Check the seal and if required, replace it.



WARNING!

Danger if incorrect lubricants used!

Unsuitable lubricant may contaminate the medium. In oxygen applications there is a risk of an explosion!

- ▶ In specific applications, e.g. oxygen or analysis applications, use appropriately authorised lubricants only.

- Grease nipple thread before re-installing the actuator (e.g. with Klüber paste UH1 96-402 from Klüber).

NOTE!

Damage to the seat seal or the seat contour!

- ▶ When installing the actuator, ensure that the valve is in open position.

- Control function A pressurize the pilot air port 1 with compressed air (5 bar): valve opens.
- Screw actuator into the valve body.
Observe tightening torque (see [“Tab. 6: Tightening torques of valve body / nipples”](#)).

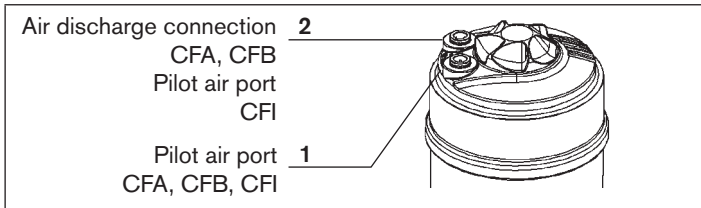

Fig. 22: Connections

Tightening torques of valve body / nipples	
Orifice	Tightening torque [Nm]
13/15	45 ±3
20	50 ±3
25	60 ±3
32	65 ±3
40	
50	70 ±3
65	100 ±3
80	120 ±5
100	150 ±5

Tab. 6: Tightening torques of valve body / nipples

! If the position of the pilot air ports for installation of the hoses is unfavorable, these can be aligned steplessly by rotating the actuator through 360°. The procedure is described in the chapter entitled [“8.3.4 Rotating the actuator”](#).

10.3.2 Replacing the packing gland



The packing gland can be changed for the device combination ø 70 / DN50 as of series-production status January 2017.

The seal set for the packing gland contains

<p>SP10 / SP14</p> <ul style="list-style-type: none"> ▪ 1 support ring ▪ 7 chevron seals ▪ 2 pressure rings ▪ 1 pressure spring ▪ 1 spindle guide ▪ 1 seal ▪ Lubricant 	
<p>SP22</p> <ul style="list-style-type: none"> ▪ 1 support ring ▪ 7 chevron seals ▪ 2 pressure rings ▪ 1 pressure spring ▪ 1 spacer ▪ 1 seal ▪ Lubricant 	

Fig. 23: Seal set for packing gland



DANGER!

Risk of injury from discharge of medium and pressure!

It is dangerous to remove a device which is under pressure due to the sudden release of pressure or discharge of medium.

- ▶ Before removing a device, switch off the pressure and vent the lines.



WARNING!

Risk of injury if the wrong tools are used!

It is dangerous to use unsuitable tools for installation work as the device may be damaged.

- ▶ To remove the actuator from the valve body, use an open-end wrench, never a pipe wrench.
- ▶ To replace the packing gland, use a special installation wrench, modified socket wrench or a socket wrench.
- ▶ Observe tightening torques.

Before the packing gland can be replaced, the actuator must be removed from the valve body and the swivel plate removed.

Remove the actuator from the valve body:

- Clamp the valve body in a holding device (applies only to valves which have not yet been installed).

NOTE!

Damage to the seat seal or the seat contour!

- ▶ When removing the actuator, ensure that the valve is in open position.

- Control function A pressurize the pilot air port 1 with compressed air (5 bar): valve opens.
- Using a suitable open-end wrench, place the wrench flat on the tube.
- Unscrew the actuator from the valve body.

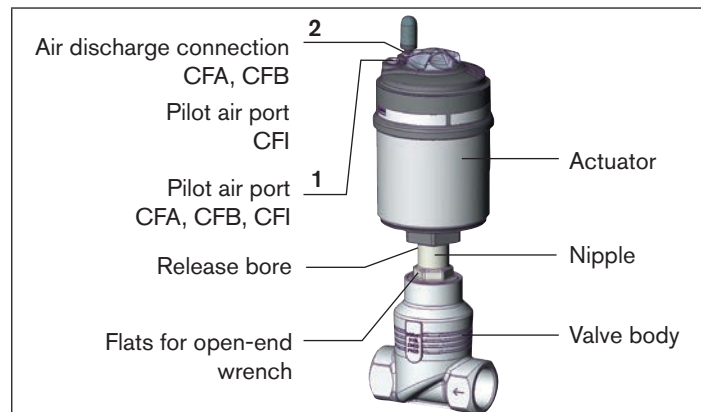

Fig. 24: Designation parts

Removing the swivel plate

- Knock out the pin with a suitable pin punch.
- Pin punch \varnothing 3 mm**, for spindle diameter 10 mm on the swivel plate.
- Pin punch \varnothing 5 mm**, for spindle diameter 14 mm on the swivel plate.
- Remove swivel plate.

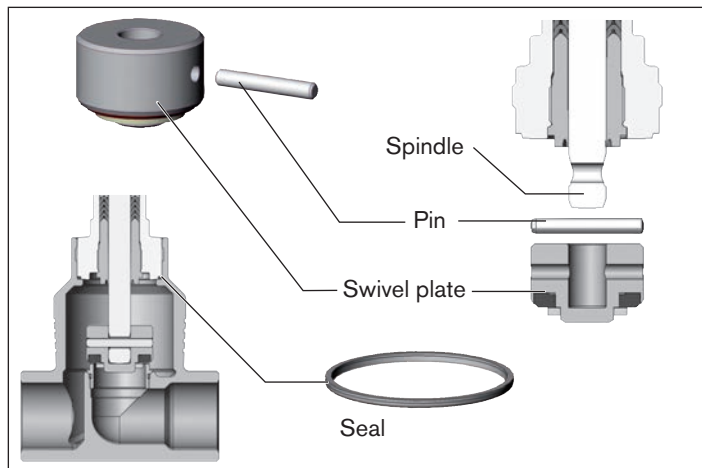

Fig. 25: Valve set

Replacing packing gland

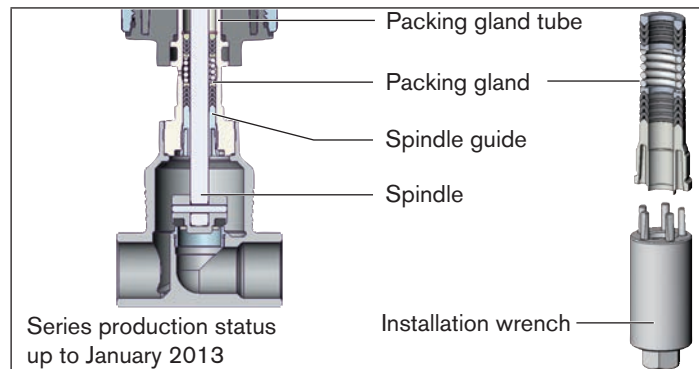

Fig. 26: Replacing packing gland (series production status up to January 2013)

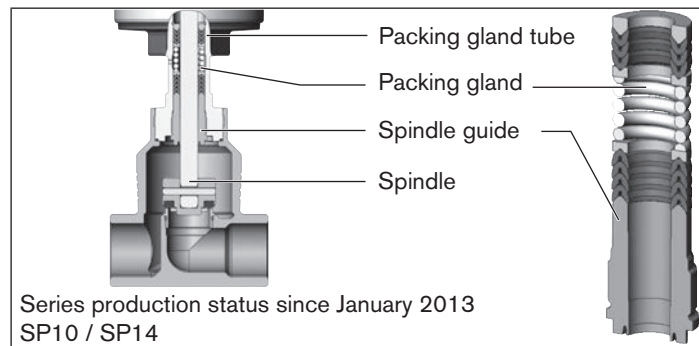

Fig. 27: Replacing packing gland SP10 / SP14 (series production status since January 2013)

Type 2101

Maintenance, Cleaning

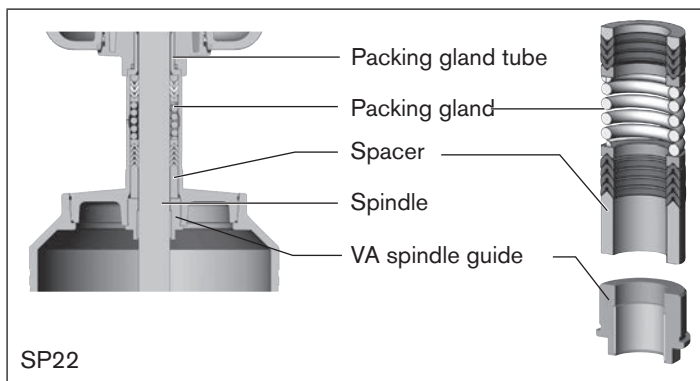

Fig. 28: Replacing packing gland SP22

Series production status up to January 2013:

→ Unscrew the spindle guide with the aid of the installation wrench⁷⁾ and an open-end wrench.

Series production status since January 2013 SP10 / SP14:

→ Unscrew the spindle guide with the aid of a modified socket wrench⁷⁾.

SP22:

→ Unscrew the VA spindle guide with the aid of an open-end wrench.

⁷⁾ The installation wrench or modified socket wrench is available from your Bürkert sales office.



WARNING!

Risk of injury from parts jumping out!

When the spindle opening is exposed, the individual parts of the packing gland are pressed out at an undefined speed when the pilot air ports is pressurized.

- ▶ Before pressurizing with control air, safeguard the ambient area of the discharge opening (e.g. place spindle on a firm base).

- **Control function A and I** Pressurize pilot air port **1** with 6 – 8 bar (see “[Fig. 24: Designation parts](#)”).
- **Control function B** Pressurize pilot air port **2** with 6 – 8 bar (see “[Fig. 24: Designation parts](#)”).
- Grease the individual parts of the new packing gland with the applied lubricant.
- Connect the individual parts to the spindle in the specified direction and sequence (as illustrated in “[Fig. 29: Seal set for packing gland](#)”).
- Push packing gland into the packing gland tube.
- Screw spindle guide / VA spindle guide back in using the socket wrench / open-end wrench. Observe torque (see “[Tab. 7: Tightening torques of spindle](#)”).

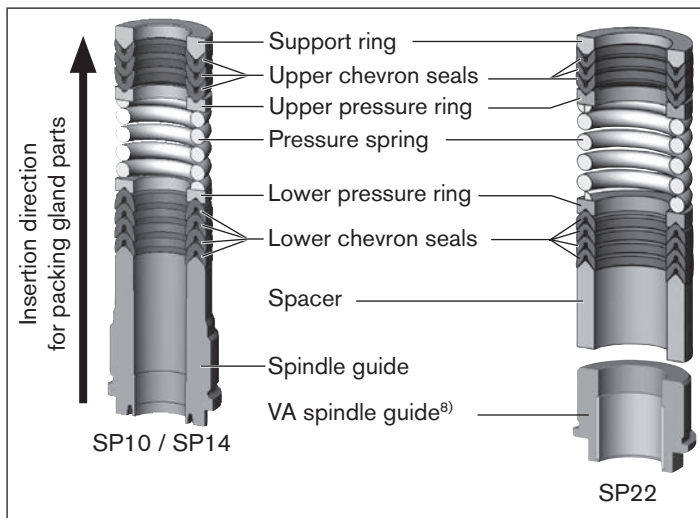

Fig. 29: Seal set for packing gland

Tightening torques of spindle	
Spindle diameter	Tightening torque [Nm]
10 mm	6
14 mm	15
22 mm	60

Tab. 7: Tightening torques of spindle

a) Is not included in the seal set

Installing swivel plate

- Connect swivel plate to the spindle.
- Align bores of the swivel plate and spindle.
- Support swivel plate on the cylindrical part with the aid of a prism or something similar.
- Insert pin into the bore.
- Swage pin bores on both sides of the swivel plate using a chisel or center punch.

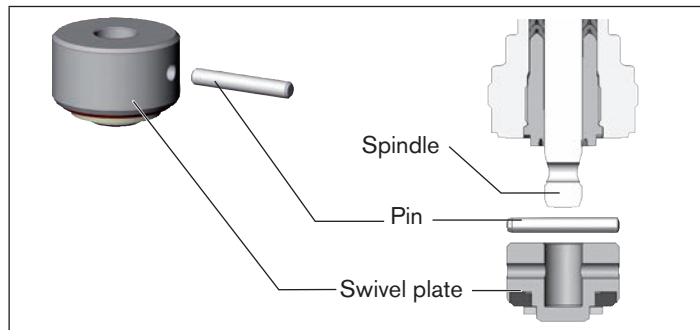

Fig. 30: Swivel plate

Installing the actuator on the valve body

For description see chapter entitled "[Installing the actuator on the valve body](#)", page 27.

11 MALFUNCTIONS

Malfunction	Remedial action
Actuator does not switch	Pilot air port interchanged ⁹⁾ CFA: → Connecting pilot air port 1 CFB: → Connecting pilot air port 1 CFI: → Pilot air port 1: Open Pilot air port 2: Close
	Pilot pressure too low → Observe pressure specifications on the type label
	Medium pressure too high → Observe pressure specifications on the type label
	Flow direction reversed → Observe direction arrow on the body

Malfunction	Remedial action
Valve is not sealed	Dirt between seal and valve seat → Installing dirt trap
	Seat seal worn → Installing new swivel plate
	Flow direction reversed → Observe direction arrow on the body
	Medium pressure too high → Observe pressure specifications on the type label
Valve is leaking on the release bore	Pilot pressure too low → Observe pressure specifications on the type label
	Packing gland worn → Renew packing gland or replace actuator

Tab. 8: *Malfunctions*

⁹⁾ See [“8.4 Pneumatic connection”](#).

12 REPLACEMENT PARTS



WARNING!

Risk of injury when opening the actuator!

The actuator contains a tensioned spring. If the actuator is opened, there is a risk of injury from the spring jumping out!

- ▶ The actuator must not be opened.



CAUTION!

Risk of injury and/or damage by the use of incorrect parts!

Incorrect accessories and unsuitable replacement parts may cause injuries and damage the device and the surrounding area.

- ▶ Use only original accessories and original replacement parts from Bürkert.

12.1 Replacement part sets

The following replacement part sets are available for the globe valve Type 2101:

- Valve set
consists of swivel plate with seal, pin and seal.
- Sealing set for packing gland
consists of the individual parts of the packing gland, seal and lubricant
(the (modified) socket wrench is not included in the sealing set).

Valve set with PTFE seal	
Orifice	Order no.
15	149 606
20	011 171
25	160 737
32	011 208
40	011 209
50	216 431
50 (Actuator size \varnothing 70) ¹⁰⁾	307 392
65	241 777
80	155 492
100	155 493

Tab. 9: Valve set with PTFE seal

Sealing set for packing gland			
Spindle \varnothing	Orifice	Actuator size	Order no.
10	15 – 50 ¹⁰⁾	\varnothing 50, \varnothing 70	216 433
14	32 – 65	\varnothing 90, \varnothing 130	216 435
22	80 – 100	\varnothing 130	252 545

Tab. 10: Sealing set for packing gland

¹⁰⁾ As of series-production status January 2017 change also possible for DN50 spindle \varnothing 10

Type 2101

Replacement parts

VA spindle guide for packing gland			
Spindle \varnothing	Orifice	Actuator size	Order no.
22	80 – 100	\varnothing 130	252 543

Tab. 11: VA spindle guide for packing gland

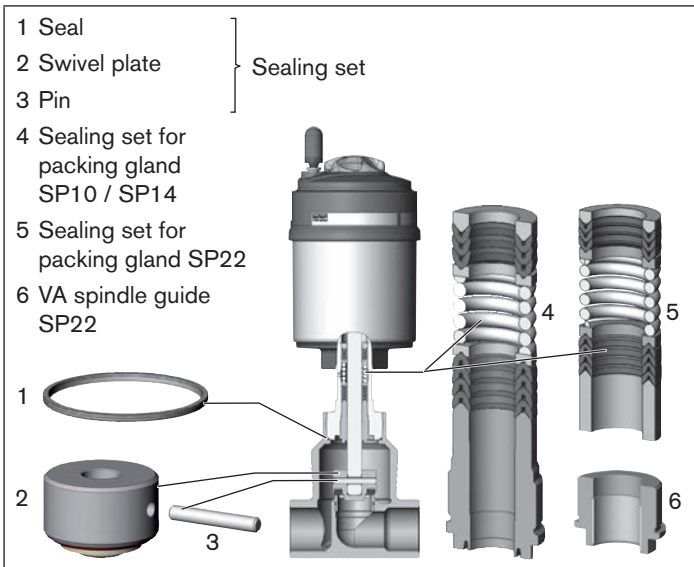

Fig. 31: Replacement parts

12.2 Installation tools

Installation wrench for packing gland (Only for removal of packing glands up to January 2013)		
Installation wrench	Orifice	Order no.
Spindle \varnothing 10 mm	15 – 40	665 700
Spindle \varnothing 14 mm	32 – 65	665 701

Tab. 12: Installation wrench

Modified socket wrench for packing gland (Series production status since January 2013)				
	Socket wrench	Orifice	AF	Order no.
	Spindle \varnothing 10 mm	15 – 50 ¹¹⁾	19	683 221
	Spindle \varnothing 14 mm	32 – 65	21	683 223

¹¹⁾ As of series-production status January 2017 also for DN50

Tab. 13: Modified socket wrench

Special wrench for rotating the actuator (Series-production status until end of 2011)	
Order no.	665 702

Tab. 14: Special wrench



If you have any queries, please contact your Bürkert sales office.

13 PACKAGING, TRANSPORT, STORAGE

NOTE!

Transport damages!

Inadequately protected equipment may be damaged during transport.

- During transportation protect the device against wet and dirt in shock-resistant packaging.
- Avoid exceeding or dropping below the permitted storage temperature.

Incorrect storage may damage the device.

- Store the device in a dry and dust-free location!
- Storage temperature: -20...+65 °C.

Damage to the environment caused by device components contaminated with media.

- ▶ Dispose of the device and packaging in an environmentally friendly manner.
- ▶ Observe applicable regulations on disposal and the environment.



Note:

Observe national waste disposal regulations.

www.burkert.com