

Insulation Tester + DMM

Model MG325

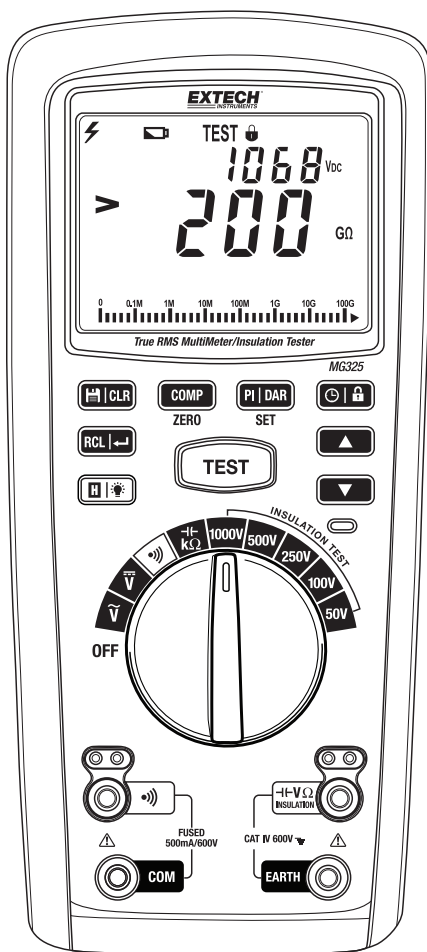

Table of Contents

1. INTRODUCTION	3
2. SAFETY	3
3. METER DESCRIPTION	5
4. CONTROL BUTTONS	6
5. SYMBOLS AND ANNUNCIATORS	6
6. OPERATING INSTRUCTIONS	7
6.1 Display Backlight	7
6.2 Data Hold	7
6.3 Low Battery Indication	7
6.4 DC VOLTAGE MEASUREMENTS	7
6.5 AC VOLTAGE MEASUREMENTS	8
6.6 RESISTANCE MEASUREMENTS	9
6.7 CONTINUITY MEASUREMENTS	10
6.8 CAPACITANCE MEASUREMENTS	11
6.9 INSULATION RESISTANCE MEASUREMENTS	12
6.9.1 Disable Lock Mode for Insulation and Continuity Tests	13
6.9.2 Insulation Resistance Test Timer	13
6.9.3 Dielectric Absorption Ratio [DAR] Insulation Testing	13
6.9.4 Polarization Index [PI] Insulation Testing	14
6.9.5 Comparator Utility	14
7. DATA RECORDING	15
8. SETUP MODE	15
9. MAINTENANCE	16
9.1 BATTERY INSTALLATION	16
9.2 REPLACING THE FUSE	16
10. SPECIFICATIONS	17

1. Introduction

Congratulations on your purchase of the MG325 True RMS Insulation Resistance CAT IV 600V DMM. The MG325 features a rugged design for heavy duty use. The MG325 measures Insulation Resistance, AC/DC Voltage, Frequency, Leakage Current, Low Resistance, Continuity, and Capacitance. Insulation Resistance tests are automatic ranging with 5 test voltages from 50V to 1000V. The MG325 can store and recall up to 99 measurements.











The MG325 is suitable for measuring the insulation resistance on electrical equipment such as transformers, motors, cables, switches, and appliances.

Proper use and care of this meter will provide years of reliable service.

Features

- DC and True RMS AC Voltage Measurements to 600V
- Insulation Resistance Measurements up to 200G
- Frequency of the AC Voltage
- Leakage Current Insulation test mode
- Capacitance Measurements
- Low Resistance and Continuity Measurements with ZERO function
- Auto Ranging measurements
- Polarization Index (PI) and Dielectric Absorption Ratio (DAR) tests
- Five (5) Insulation Resistance test voltages (50, 100, 250, 500, and 1000V)
- Insulation Resistance tests in 10% voltage steps (from 50% to 120% of range)
- Eight (8) Insulation Resistance measurement ranges (automatic ranging)
- Pass/Fail Comparator function for Insulation Resistance and Continuity
- Auto-discharge at end of test
- Output voltage alert light and display symbols
- Hand's free test lock feature
- Manually store and recall up to 99 readings
- Overload indication
- Remote test probe for controlling the TEST button remotely
- Test leads, alligator clips, batteries, user manual, and case included

2. Safety

	Warning and Caution safety label
	Double Insulation
	DC Direct Current
	AC Alternating Current
	Low Battery
	Fuse symbol
	High Voltage Alert
	Audible beeper
	Earth ground
	Complies with EC standard

PER IEC1010 OVERVOLTAGE INSTALLATION CATEGORY

OVERVOLTAGE CATEGORY I

Equipment of OVERVOLTAGE CATEGORY I is equipment for connection to circuits in which measures are taken to limit the transient over-voltages to an appropriate low level.

Note – Examples include protected electronic circuits.

OVERVOLTAGE CATEGORY II

Equipment of OVERVOLTAGE CATEGORY II is energy-consuming equipment to be supplied from the fixed installation.

Note – Examples include household, office, and laboratory appliances.

OVERVOLTAGE CATEGORY III

Equipment of OVERVOLTAGE CATEGORY III is equipment in fixed installations.

Note – Examples include switches in the fixed installation and some equipment for industrial use with permanent connection to the fixed installation.

OVERVOLTAGE CATEGORY IV

Equipment of OVERVOLTAGE CATEGORY IV is for use at the origin of the installation.

Note – Examples include electricity meters and primary over-current protection equipment

SAFETY INSTRUCTIONS

This meter has been designed for safe use, but must be operated with caution. The rules listed below must be carefully followed for safe operation.

1. **NEVER** apply voltage to the meter that exceeds the specified maximum:

Input Protection Limits	
Function	Maximum Input
V DC or V AC	600VDC/AC rms
Low Resistance	250VDC/AC rms
Capacitance	250VDC/AC rms
Insulation Resistance and Continuity	250VDC/AC rms
Surge Protection: 8kV peak per IEC 61010	

2. **USE EXTREME CAUTION** when working with high voltages.
3. **DO NOT** measure voltage if the voltage on the "COM" input jack exceeds 600V above earth ground.
4. **NEVER** connect the meter leads across a voltage source while the function switch is in the resistance mode. Doing so can damage the meter.
5. **ALWAYS** discharge filter capacitors in power supplies and disconnect the power when making resistance, continuity, and capacitance tests.
6. **ALWAYS** turn off the power and disconnect the test leads before opening the covers to replace the fuse or batteries.
7. **NEVER** operate the meter unless the battery/fuse cover is in place and fastened securely.
8. If the equipment is used in a manner not specified by the manufacturer, the protection provided by the equipment may be impaired.

SAFETY STANDARDS

This instrument is designed and produced strictly in accordance with the safety requirements for GB4793 electronic measuring instruments and IEC61010-1 safety standards. This instrument meets the double insulation over-voltage standard CAT IV 600V and pollution degree II. Failure to use the instrument as described in this user manual can weaken or negate the protections provided.

- Check the instrument, test leads, and test pen before use. Check for any abnormal conditions such as exposed test lead wire, damaged meter housing, no display or random display errors.
- Do not use this instrument with an open battery compartment.
- Damaged test leads must be replaced with those of the same type or specifications.
- Do not touch bare wires or conductors, unused input terminals, or the circuit being measured when the instrument is in operation.
- Use caution when measuring voltages greater than 42V DC or 30V AC. Keep fingers behind the finger guard on the test leads to avoid electrical shocks when measuring.
- Do not apply signals greater than those specified between any two terminals or any terminal and ground.
- Set the function switch the correct position before beginning a test. Never move the function switch during a test. Please stop testing and remove connections to the circuit under test before moving the function switch to a new position.
- Do not store or use the instrument in an explosive or flammable environment or an environment characterized by high temperature, high humidity, or strong electromagnetic fields.
- There are no user-serviceable parts in this instrument. Please refer all service and repairs to Extech Instruments.
- Replace the batteries as soon as the low battery icon appears in order to ensure the highest measurement accuracy.

3. Meter Description

1. 5999 count backlit LCD display with bargraph
2. Control buttons; detailed in next section
3. Rotary function switch
4. Continuity (+) positive input jack
5. Continuity (-) COM input jack
6. Insulation, Voltage, Capacitance, Resistance (-) input jack
7. Insulation, Voltage, Capacitance, Resistance (+) input jack
8. Test Voltage alert LED indicator

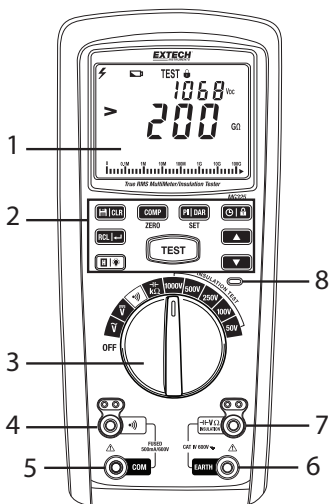

Note: Tilt stand and battery compartment on back

4. Control buttons

- Data Hold on/off (short press) for AC/DC Voltage, Resistance and Capacitance modes only. Also for display Backlight on/off (long press)
- Short press to Recall stored readings. Another short press to exit this mode. Also used as an ENTER confirmation button in SETUP mode.
- Save reading (short press) and Clear all stored readings (long press)
- Comparator (short press) and Zero (long press)
- PI and DAR test mode selection (short presses). Also used to access the SETUP mode (long press) where Insulation Resistance and Continuity tests can be customized.
- Insulation Test Lock button (long press to activate/deactivate lock mode)
- Up arrow for menu navigation and for scrolling recalled readings
- Down arrow for menu navigation and scrolling recalled readings. Also used to select capacitance or resistance modes when the function switch is set to the capacitance and resistance position.
- Press to start Insulation or Low Resistance tests. Insulation tests output high voltages and measure insulation resistance.

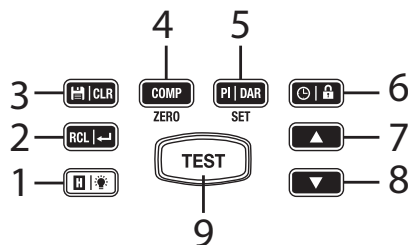

5. Symbols and Annunciators

- Test voltage output alert
- ZERO function
- Battery status
- Audible beeper
- TEST in progress
- Test lock ON
- PI/DAR test modes
- Elapsed Timer ON
- Auxiliary display
- Main display
- PI/DAR test time area
- Bargraph measurement representation
- Comparator area: Test [PASS, FAIL], units [K, MΩ], and reference value.
- Over-range alert symbol
- Save/Recall readings memory (01-99); Data Hold [H] icon is also shown in this area

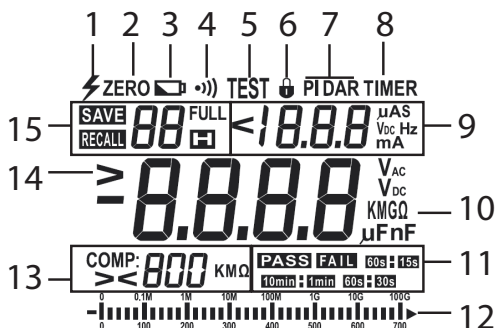

6. Operating Instructions



WARNING: Risk of electrocution. High-voltage circuits, both AC and DC, are very dangerous and should be measured with great care.

1. ALWAYS turn the function switch to the **OFF** position when the meter is not in use.
2. If “>” appears in the display during a measurement, the value exceeds the maximum range of the meter.

6.1 Display Backlight

Press and hold the  button to switch the backlight on or off. Excessive use of the backlight will cause the batteries to drain quicker.

6.2 Data Hold

The Data Hold function freezes the reading in the display. To freeze or unfreeze the reading, press **H** (Data Hold) key. The **H** icon is shown when data hold is active. This mode is only available for the AC/DC Voltage, Resistance, and Capacitance modes.

6.3 Low Battery Indication

When the  icon appears in the display, the battery must be replaced. See the Maintenance section for details on battery and fuse replacement.



6.4 DC VOLTAGE MEASUREMENTS



CAUTION:

When the measured voltage is > 42VDC or 600VAC the meter flashes the warning icon on the upper left.

Do not measure DC voltages if a motor on the circuit is being switched ON or OFF. Large voltage surges may occur that can damage the meter.

1. Set the function switch to the  position.
2. Insert the black test lead banana plug into the negative **EARTH** jack (6).
Insert the red test lead banana plug into the positive **V** jack (7).
3. Touch the black test probe tip to the negative side of the circuit.
Touch the red test probe tip to the positive side of the circuit.
4. Read the Voltage in the main display and in the lower bargraph.
5. Press the  button to store the reading.
6. Short press the **H** (Hold) button to freeze (**H** icon displayed) or unfreeze (no **H** icon displayed) the displayed reading.
7. Note that the Auto Power OFF function activates after 10 minutes of inactivity. The meter will audibly beep just prior to shutting off.

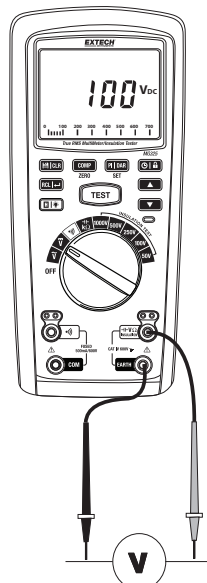

6.5 AC VOLTAGE MEASUREMENTS



WARNING: Risk of Electrocution. The probe tips may not be long enough to contact the live parts inside some 240V outlets for appliances because the contacts are recessed deep in the outlets. As a result, the reading may show 0 volts when the outlet actually has voltage on it. Make sure the probe tips are touching the metal contacts inside the outlet before assuming that no voltage is present.



CAUTION

Do not measure AC voltages if a motor on the circuit is being switched ON or OFF. Large voltage surges may occur that can damage the meter.

Do not measure voltages higher than 600V

When the measured voltage is > 60VDC or 600VAC the meter flashes the warning icon on the upper left.

Do not measure AC voltages if a motor on the circuit is being switched ON or OFF. Large voltage surges may occur that can damage the meter.

1. Set the function switch to the \tilde{V} position.
2. Insert the black test lead banana plug into the negative **EARTH** jack (6).
Insert red test lead banana plug into the positive **V** jack (7).
3. Touch the black test probe tip to the neutral side of the circuit.
Touch the red test probe tip to the “hot” side of the circuit.
4. Read the voltage in the main display and in the lower bargraph.
5. Read the Frequency in the auxiliary display (upper right)
6. Short press the **H** (Hold) button to freeze (**H** icon displayed) or unfreeze (no **H** icon displayed) the displayed reading.
7. Press **MEM | CLR** to store the reading
8. Note that the Auto Power OFF function activates after 10 minutes of inactivity. The meter will audibly beep just prior to shutting off.

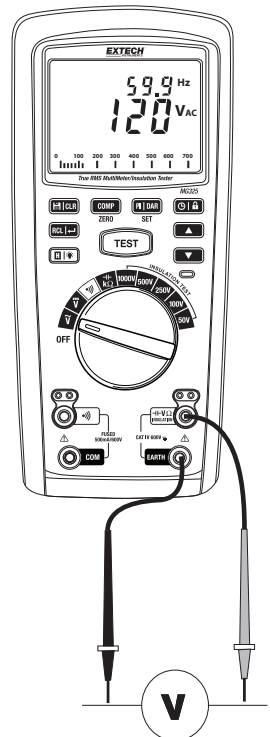



6.6 RESISTANCE MEASUREMENTS



WARNING: To avoid electric shock, disconnect power to the unit under test and discharge all capacitors before taking resistance measurements. Remove the batteries and unplug the line cords.



WARNING: To avoid electric shock, never measure resistance on circuits or wires that have a voltage.

1. Set the function switch to the Ω position.
2. Insert the black test lead banana plug into the negative **EARTH** jack (6).
Insert the red test lead banana plug into the positive Ω jack (7).
3. Use the  button to choose the Resistance mode (the  button toggles Capacitance and Resistance modes).
4. Reset the display to zero before testing: Short the test probes and note the value. Short the test probes again and press and hold **ZERO** until **ZERO** is displayed (0.00 Ω reading when successful). Press and hold **ZERO** again to exit.
5. Before testing, it is best to disconnect one side of the part under test so that other circuits do not interfere with the resistance reading.
6. Touch the test probe tips across the circuit or part under test.
7. Read the resistance in the main display and with the lower bargraph.
8. If the circuit is open, the display will indicate ">". If 2V or more are sensed on the device under test, the meter will stop the test.
9. Short press the **H** (Hold) button to freeze (**H** icon displayed) or unfreeze (no **H** icon displayed) the displayed reading.
10. Press  to store the reading
11. Note that the Auto Power OFF function activates after 10 minutes of inactivity. The meter will audibly beep just prior to shutting off.

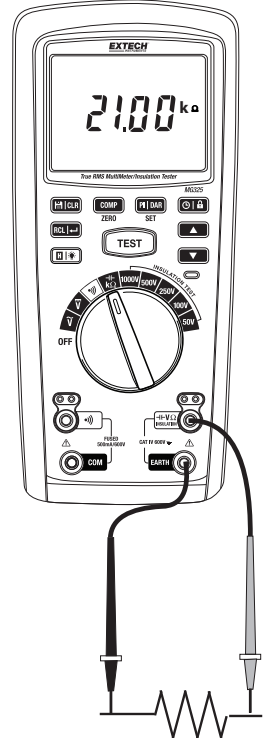

6.7 CONTINUITY MEASUREMENTS



WARNING: To avoid electric shock, disconnect power to the unit under test and discharge all capacitors before taking continuity measurements. Remove the batteries and unplug the line cords.



WARNING: To avoid electric shock, never measure continuity on circuits or wires that have a voltage.

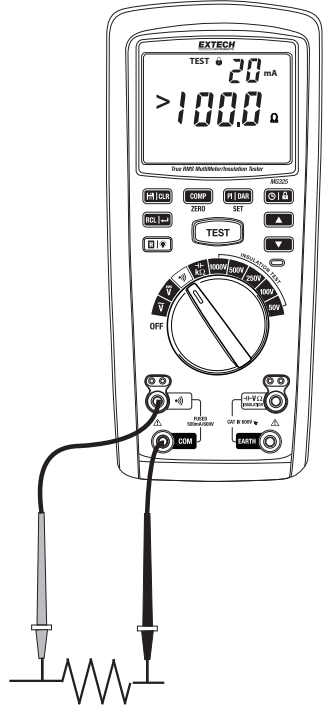

1. Set the function switch to the Ω position.
2. Insert the black test lead banana plug into the negative **COM** jack (5).
Insert the red test lead banana plug into the positive Ω jack (4).
3. Press the **TEST** button on the meter (or on the test leads, if using the test lead with the **TEST** button) to put the meter in test mode. The display will show **TEST** and the alert LED will light.
4. The meter defaults to test lock mode (lock icon displayed) so the test will run without having to hold **TEST**. Press and hold the lock button to change to manual test mode (**TEST** button must be held throughout the test).
5. Reset the display to zero before testing: Short the test probes and note the value. Short the test probes again and press and hold **ZERO** until **ZERO** is displayed (0.00 Ω reading when successful). Press and hold **ZERO** again to exit.
6. Touch the test probe tips across the circuit or part under test.
7. If the continuity buzzer is turned on in the SETUP mode, the buzzer will sound if the resistance $<30\Omega$. Read the resistance in the main display and with the lower bargraph.
8. If the circuit is open, the display will indicate ">". If 2V or more are sensed on the device under test, the meter will stop the test and **'UE HI TEST'** will display.
9. If the **'FU FAIL'** prompt appears, the fuse must be replaced before use (see the Maintenance section for fuse and battery replacement information).
10. Short press the **H** (Hold) button to freeze (**H** icon displayed) or unfreeze (no **H** icon displayed) the displayed reading.
11. Press  to store the reading
12. Note that the Auto Power OFF function activates after 10 minutes of inactivity. The meter will audibly beep just prior to shutting off.



6.8 CAPACITANCE MEASUREMENTS



WARNING: To avoid electric shock, discharge capacitors before measuring them.

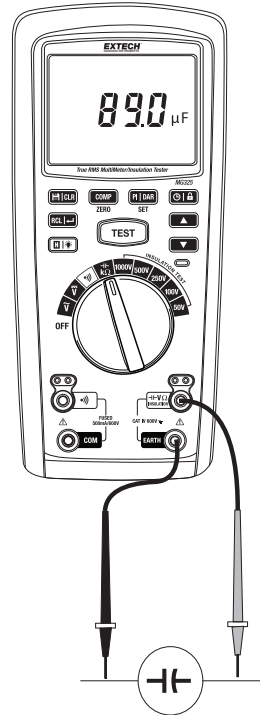

1. Set the function switch to the C position.
2. Insert the black test lead banana plug into the negative **EARTH** jack (6).
Insert the red test lead banana plug into the positive C jack (7).
3. Use the  button to choose the Capacitance mode (the  button toggles Capacitance and Resistance modes).
4. Touch the test probe tips across the circuit or part under test.
5. Read the capacitance in the main display and with the lower bargraph.
6. Short press the **H** (Hold) button to freeze (**H** icon displayed) or unfreeze (no **H** icon displayed) the displayed reading.
7. Press  to store the reading

Note that the Auto Power OFF function activates after 10 minutes of inactivity. The meter will audibly beep just prior to shutting off.



6.9 INSULATION RESISTANCE MEASUREMENTS

Note: Disconnect the unit under test from all power sources and isolate it from any stray resistance.

1. Connect the red test lead to the meter's **INSULATION (+)** jack (7) and the black test lead to the **EARTH (-)** jack (6). Connect the probe end of the test leads to the circuit under test.
2. Set the rotary function switch to one of the Insulation Resistance test positions (50V, 100V, 250V, 500V, or 1000V); the selected test voltage is indicated on the auxiliary display.
3. Press the **TEST** button on the meter (or on the test leads, if using the test lead with the **TEST** button) to start testing (**TEST** will display).
4. The primary display and the analog bargraph will show the insulation resistance in Ω .
5. The test voltage (VDC) value will be indicated in the auxiliary display, the ⚡ symbol will flash and the front panel red LED will light. While the test is running, press  to change the test voltage display in the auxiliary display to the measured leakage current display.
6. The meter defaults to test lock mode (lock icon displayed) so the test will run without having to hold the **TEST** button.
7. Press the **TEST** button to stop the test.
8. At the end of each test the high voltage switches off (alert symbol ⚡ and LED light switch off), the measured resistance value is held in the primary display, and the meter internally discharges the balance of the test voltage.
9. Short press the **H** (Hold) button to freeze (**H** icon) or unfreeze (no **H** icon) the displayed reading.
10. Press  to store the reading
11. Use the SETUP mode to fine tune test voltage, set the default test time, and set a comparator reference value. See the SETUP mode section for more details.

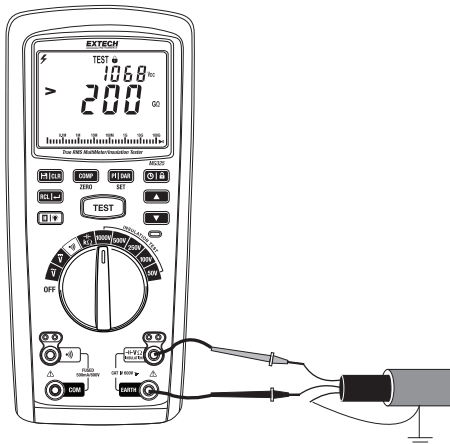

Note: If the circuit under test is live and has a voltage potential (AC/DC) over 25V, the meter will not test (the display will show ">25V", the ⚡ symbol will flash, and the buzzer will sound). If the circuit under test is not live or if its voltage is less than 25V, the meter will begin applying voltage to the circuit under test.

Note: Do not turn the function switch to another test position during a test. Please wait until a test is completed and test leads are removed from the device under test before moving the function switch.





6.9.1 Disable Lock Mode for Insulation and Continuity Tests

To disable test lock mode and use manual test mode, press and hold the  button until the lock icon switches off and then press and hold the **TEST** button for the duration of the test (**TEST** will be displayed). Release the button to stop the test.

6.9.2 Insulation Resistance Test Timer

Please read and understand the sections on Insulation Resistance testing and Safety before continuing.

The MG325 can run an Insulation test for an indefinite period by pressing the TEST button to start/stop tests (Timer function OFF) or it can be programmed to run a test for a specific period of time, 1~10 minutes (Timer function ON).

1. Short press the  button to turn the test timer ON or OFF (the **TIMER** icon will display when the timer is active).
2. The test time, while the Insulation Resistance test is running, is shown in the auxiliary display in 'seconds' (s).
3. To set the test time, press and hold the SETUP button to enter the SETUP mode. Press  to step to the 2nd menu item (test time) and use the arrow buttons to select a test time between 1~10 minutes. Press  to confirm the setting and then press and hold the SETUP button to exit the SETUP mode. See SETUP mode section for additional details.
4. Now when Insulation tests are run, and the  button is pressed, the tests will stop automatically after the programmed test time has elapsed.
5. Press  to turn this function off (TIMER display prompt will switch OFF).

6.9.3 Dielectric Absorption Ratio [DAR] Insulation Testing

Read and understand all operations and safety information in the Insulation Resistance measurement and Safety sections before continuing.

1. Connect the meter to the device under test as shown in the Insulation Resistance test section above.
2. Select the desired output test voltage using the rotary function switch.
3. Use the **PI/DAR** button to step to the first DAR test mode (60 seconds : 15 seconds ratio test) or to the second DAR test mode (60 seconds : 30 seconds ratio test).
4. The display will show the DAR icon when the DAR mode is successfully accessed.
5. The test time ratio will show on the lower right.
6. Press the **TEST** button to start the test.
7. During the test the auxiliary display digits show the elapsed time, the voltage alert flashes on the upper left, and the 'test voltage alert' LED will light.
8. The test will stop automatically after 60 seconds.

6.9.4 Polarization Index [PI] Insulation Testing



Read and understand all operations and safety information contained in the Insulation Resistance measurement section above and the Safety section before continuing.

1. Connect the meter to the device under test as shown in the Insulation test section above.
2. Select the desired output test voltage using the rotary function switch.
3. Use the **PI/DAR** button to access the PI test mode.
4. The display will show the **PI** icon when the PI mode is successfully accessed.
5. The test times (10 minutes : 1 minute) will show on the lower right.
6. Press the **TEST** button to start the test.
7. During the test the auxiliary display digits show the test time in seconds, the voltage alert flashes on the upper left, and the 'test voltage alert' LED illuminates.
8. The test will stop automatically after 10 minutes.

6.9.5 Comparator Utility





Read and understand all operations and safety information contained in the Insulation Resistance and Continuity measurement sections and the Safety sections before continuing.

In Comparator mode the meter compares Insulation Resistance or Continuity measurements to a preset resistance value and displays **PASS** (measured value greater than reference value) or **FAIL** (measured value lower than reference value).

1. Connect the meter to the device under test as shown in the Insulation Resistance or Continuity test sections above.
2. Press the **COMP** button momentarily and the **COMP** icon will appear on the lower left, next to the comparison resistance value.
3. Press and hold the **SET** button until the **SET** icon is shown.
4. Use the  button to step to the **COMP** screen (see the SETUP mode section below for more details on the SETUP mode).
5. Use the arrow buttons to step to the desired reference value.
6. Press  to confirm setting.
7. Press and hold the **SET** button to return to the test mode.
8. Press **COMP** momentarily and the **COMP** icon will appear.
9. Press the **TEST** button to start the test. If the measurement is greater than the reference then the test passes and **PASS** will be displayed; if the measured value is lower than the reference then the test fails and **FAIL** is displayed.
10. The Insulation Resistance comparator preset options are: 500k, 1M, 2M, 5M, 10M, 20M, 50M, 100M, 200m, and 500MΩ.
11. The Continuity comparator preset options are: 1, 2, 5, 10, and 20Ω.

7. Data Recording



The MG325 can store, recall, and clear up to 99 readings (01-99).

1. Press the  **CLR** button to save a displayed reading.
2. The displayed counter increments to the next available memory location.
3. To recall a reading, press the  button (**RECALL** will be displayed). Use the arrow buttons to scroll the stored readings. The stored reading counter keeps track of the memory location (01-99). Press  again to return to the normal mode.
4. Press and hold the  **CLR** button for 2 seconds to erase all memory location data.



8. Setup Mode

In the SETUP Mode the user can customize **Insulation Resistance** and **Continuity** tests.

When in the **Insulation Resistance** test mode:

1. Press and hold the **SET** button until **SET** is shown. The selected test voltage will be shown (blinking) in the upper right corner of the display.
2. Use the arrow buttons to fine tune the test voltage (from 50% to 120% of the range)
3. Press  to confirm and to step to the default test time.
4. Use the arrow buttons to set the default test time (from 1 to 10 minutes).
5. Press  to confirm and to step to the comparator reference value setting.
6. Use the arrow buttons to select the comparator reference value (from 500k Ω to 500M Ω).
7. Press  to confirm the setting.
8. Press and hold the **SET** button until the **SET** display icon switches off

When in the **Continuity** mode:

1. Press and hold the **SET** button until **SET** is shown. The selected test current will be shown (blinking) in the upper right corner of the display.
2. Use the arrow buttons to select the test current (20mA/200mA)
3. Press  to confirm and to step to the comparator reference value.
4. Use the arrow buttons to set the comparator reference value (1, 2, 5, 10, or 20 Ω).
5. Press  to confirm and to step to the Continuity buzzer ON/OFF setting.
6. Use the arrow buttons to set the Continuity buzzer ON or OFF.
7. Press the  button to confirm the setting.
8. Press and hold the **SET** button until the **SET** display icon switches off.

9. Maintenance

WARNING: To avoid electric shock, disconnect the test leads from any source of voltage before removing the back cover or the battery or fuse covers.

WARNING: To avoid electric shock, do not operate your meter until the battery and fuse covers are in place and fastened securely.

This Instrument is designed to provide years of dependable service, if the following care instructions are performed:

1. **KEEP THE METER DRY.** If it gets wet, wipe it off.
2. **USE AND STORE THE METER IN NORMAL TEMPERATURES.** Temperature extremes can shorten the life of the electronic parts and distort or melt plastic parts.
3. **HANDLE THE METER GENTLY AND CAREFULLY.** Dropping it can damage the electronic parts or the case.
4. **KEEP THE METER CLEAN.** Wipe the case occasionally with a damp cloth. **DO NOT** use chemicals, cleaning solvents, or detergents.
5. **USE ONLY FRESH BATTERIES OF THE RECOMMENDED SIZE AND TYPE.** Remove old or weak batteries so they do not leak and damage the unit.
6. **IF THE METER IS TO BE STORED FOR A LONG PERIOD OF TIME,** the batteries should be removed to prevent damage to the unit.

9.1 BATTERY INSTALLATION

WARNING: To avoid electric shock, disconnect the test leads from any source of voltage before removing the battery cover.

1. Turn power off and disconnect the test leads from the meter.
2. Open the rear battery cover by removing three screws using a Phillips screwdriver.
3. Insert the six (6) 1.5V AA batteries into battery holder, observing the correct polarity.
4. Put the battery cover back in place. Secure with the screws.

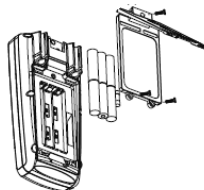

You, as the end user, are legally bound (**EU Battery ordinance**) to return all used batteries, **disposal in the household garbage is prohibited!** You can hand over your used batteries / accumulators at collection points in your community or wherever batteries / accumulators are sold!

Disposal: Follow the valid legal stipulations in respect of the disposal of the device at the end of its lifecycle

WARNING: To avoid electric shock, do not operate meter until the battery cover is in place and fastened securely.

9.2 REPLACING THE FUSE

WARNING: To avoid electric shock, disconnect the test leads from any source of voltage before removing the meter cover.

1. Disconnect the test leads from the meter.
2. To replace the 500mA/600V fuse, remove the battery cover (three Phillips screws); the fuse will be visible to the right of the batteries (recessed).
3. Gently remove the old fuse and install the new fuse into the holder.
4. Always use a fuse of the proper size and value (500mA/600V fast blow).
5. Replace and secure the rear battery cover.

WARNING: To avoid electric shock, do not operate meter until the fuse cover is in place and fastened securely.

10. Specifications

Function	Range	Resolution	Accuracy		
DC Voltage	±600V	0.01V to 1V	±(2.0% reading + 3 digits)		
AC Voltage	0~600V	0.01V to 1V	±(1.5% reading + 5 digits)		
	Specified from 5% of range to 100% of range				
	Input impedance: 10MΩ Frequency 45~400Hz (unspecified for frequency >400Hz) Input protection: 600V DC and AC rms				
Frequency	45~1kHz	0.1Hz	±(0.1% reading + 3 digits); 45~450Hz		
	Frequency measurements are shown for ACV tests in the auxiliary display area Measurements 450Hz~1kHz are for reference only; accuracy not specified				
Continuity	0.01~100Ω (@ 20mA test current)	0.01~0.1Ω	±(1.5% reading + 5 digits)		
	0.01~100Ω (@ 200mA test current)	0.01~0.1Ω	±(1.5% reading + 4 digits)		
	Continuity threshold 30Ω (programmable ON/OFF continuity buzzer) Open Circuit Voltage: 5V approximately				
Resistance	0.001k~10MΩ	0.001kΩ~0.1MΩ	±(3.0% reading + 3 digits)		
Capacitance	0.1nF~500μF	0.1nF~0.1μF	±(5.0% reading + 5 digits)		
Insulation Resistance Measurements					
Test Voltage	Range	Min. Resolution	Accuracy		
50V	0.00M~0.99GΩ	0.01MΩ ~ 0.01GΩ	±(3% + 3 digits)		
	1.00G~10.0GΩ	0.01GΩ ~ 0.1GΩ	±(3% + 3 digits) reading; ±4%/GΩ		
100V	0.00M~0.99GΩ	0.01MΩ ~ 0.01GΩ	±(3% + 3 digits)		
	1.00G~20.0GΩ	0.01GΩ ~ 0.1GΩ	±(3% + 3 digits) reading; ±2%/GΩ		
250V	0.00M~0.99GΩ	0.01MΩ ~ 0.01GΩ	±(3% + 3 digits)		
	1.00G~50GΩ	0.01GΩ ~ 0.1GΩ	±(3% + 3 digits) reading; ±0.8%/GΩ		
500V	0.00M~0.99GΩ	0.01MΩ ~ 0.01GΩ	±(3% + 3 digits)		
	1.00G~100GΩ	0.01GΩ ~ 0.1GΩ	±(3% + 3 digits) reading; ±0.4%/GΩ		
1000V	0.00M~0.99GΩ	0.01MΩ ~ 0.01GΩ	±(3% + 3 digits)		
	1.00G~200GΩ	0.01GΩ ~ 0.1GΩ	±(3% + 3 digits) reading; ±0.2%/GΩ		
Short-circuit current < 2mA 250V DC and AC rms input limit					
Insulation Resistance Test Voltage Outputs					
Output Voltage	Test Steps (50~120%)	Load	Overload	Test current	Short-circuit current
50V (0%~+20%)	(25~60V)	50kΩ	250VAC/DC	1mA	≤2mA
100V (0%~+20%)	(50~120V)	100kΩ	250VAC/DC	1mA	≤2mA
250V (0%~+20%)	(125~300V)	250kΩ	250VAC/DC	1mA	≤2mA

500V (0%~+20%)	(250~600V)	500kΩ	250VAC/DC	1mA	≤2mA
1000V (0%~+20%)	(500~1200V)	1MΩ	250VAC/DC	1mA	≤2mA
Operating range per EN61557: 0.10MΩ~1.00GΩ (output voltage ≥/≠ 50V) Short-circuit current: 2mA (0%~50%) Leakage current accuracy: ± (10% + 3 digits) Test voltage output step range is 50%~120% in 10% steps					

Note: Accuracy is stated at 23°C (75°F) and 45~75% RH.

Note: Calibration interval: 1 year maximum

Note: Temperature coefficient: 0.1 x stated accuracy/°C

Note: Accuracy specifications consist of two elements:

- (% reading) This is the accuracy of the measurement circuit.
- (+ digits) This is the accuracy of the analog to digital converter.

General Specifications

Display	5999 count, backlit, LCD with bargraph
Ranging	Automatic
Storage capacity	99 records (01-99)
Input Impedance	>10MΩ
AC Response	True rms
ACV Bandwidth	45Hz to 400Hz
Over range indication	">" is displayed in Insulation Resistance and Continuity modes
Auto Power Off	After 10 minutes of inactivity
Polarity	Automatic (no indication for positive); Minus (-) sign for negative
Measurement Rate	2 times per second, nominal
Low Battery Indication	"  " is displayed if battery drops below operating voltage
Battery	Six (6) 1.5V 'AA' batteries
Consumption	500mA (at a 1000V test voltage); 17mA in nominal conditions
Fuse	500mA/600V fast blow
Enclosure	Double molded, IP 40
Operating Temperature	0°C~40°C (32°F~104°F)
Storage Temperature	-20°C~60°C (-4°F~140°F)
Operating Humidity	<85%
Storage Humidity	<90%
Operating Altitude	2000m (7000ft.) maximum
Weight	0.7kg (1.5 lbs.) with batteries
Size	225[L] x 103[W] x 59[D] mm (8.8[L] x 4.1[W] x 2.3[D] in.)
Safety	This instrument is designed in strict compliance with safety standard IEC61010, overvoltage standard (CAT IV 600V) and pollution degree II.

Copyright © 2016 FLIR Systems, Inc.

All rights reserved including the right of reproduction in whole or in part in any form

www.extech.com