

## Data Sheet

# Manual presetting valves LENO™ MSV-BD

### Description

LENO™ MSV-BD is a range of manual valves for balancing flow in heating, cooling and domestic hot water systems.

LENO™ MSV-BD is a combined presetting and shut off valve with a range of unique features:

- Removable hand wheel for easy mounting.
- 360° turnable measuring station for convenient measuring and draining.
- Numeric presetting scale, visible from more angles.
- Easy locking of presetting.
- Built-in test plugs for Ø 3 mm needles.
- Drain connection with separate draining of inlet and outlet side of valve.
- Open-close with Allen key for extra force.
- Open-closed colour indicator.

It is recommended to use LENO™ MSV-BD in constant flow systems. The valve may be mounted in flow or return.

DN 15 and 20 valves are available with internal or external thread. Other dimensions with internal thread.

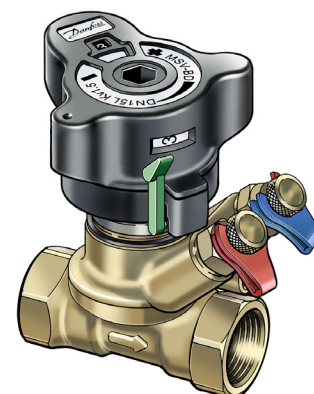

Danfoss PFM 5001/PFM 100 measuring instruments contain valve data for LENO™ MSV-BD in memory.

### Application

#### Boiler, flat station or heat pump in 1-family houses

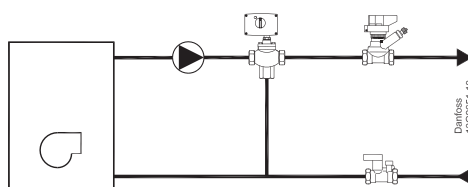

- For balancing.
- Shut-off function for service/repair.

#### Air handling unit

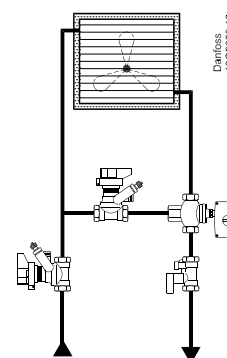

- For constant flow.
- For balancing.
- Shut-off function for service/repair.

Application

Fan coils

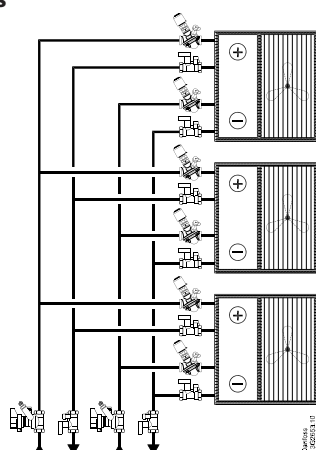

- For flow verification.
- Shut-off function for service/repair.

1-pipe system

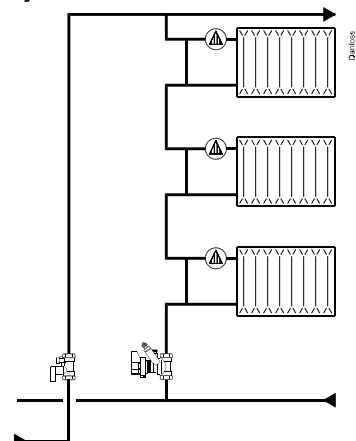

- For balancing.
- Shut-off function for service/repair.

Ordering



LENO™ MSV-BD valve with internal thread

Type	Material	Size	$k_{VS}(m^3/h)$	Connection	Quantity	Code no.
	DZR brass <sup>1)</sup>	DN 15 LF	2.5	1/2"	1	<b>003Z4000</b>
		DN 15	3.0	1/2"	1	<b>003Z4001</b>
		DN 20	6.6	3/4"	1	<b>003Z4002</b>
		DN 25	9.5	1"	1	<b>003Z4003</b>
		DN 32	18	1 1/4"	1	<b>003Z4004</b>
		DN 40	26	1 1/2"	1	<b>003Z4005</b>
		DN 50	40	2"	1	<b>003Z4006</b>
		DN 15	3.0	1/2"	8	<b>003Z4261</b>
		DN 20	6.6	3/4"	8	<b>003Z4262</b>
DN 25	9.5	1"	8	<b>003Z4263</b>		

LENO™ MSV-BD valve with external thread

Type	Material	Size	$k_{VS}(m^3/h)$	Connection	Code no.
	DZR brass <sup>1)</sup>	DN 15 LF	2.5	G 3/4 A <sup>2)</sup>	<b>003Z4100</b>
		DN 15	3.0	G 3/4 A <sup>2)</sup>	<b>003Z4101</b>
		DN 20	6.6	G 1 A	<b>003Z4102</b>

LENO™ MSV-BD/S set solution

Type	Material	Size	$k_{VS}(m^3/h)$	Drain flow <sup>3)</sup> (l/h)	Connection	Code no.
 	DZR brass <sup>1)</sup>	DN 15	3.0	281	1/2"	<b>003Z4051</b>
		DN 20	6.6	277	3/4"	<b>003Z4052</b>
		DN 25	9.5	316	1"	<b>003Z4053</b>
		DN 32	18	305	1 1/4"	<b>003Z4054</b>
		DN 40	26	208	1 1/2"	<b>003Z4055</b>
		DN 50	40	308	2"	<b>003Z4056</b>

<sup>1)</sup> Corrosion resistant brass

<sup>2)</sup> Eurocone DIN V 3838

<sup>3)</sup> Drain flow is measured at 1 bar static pressure and 0.1 bar differential pressure.

**Accessories**
**Accessories**

Type	Code no.
Standard test plugs, 2 pcs.	003Z4662
Measuring test plugs, 53 mm, red and blue	003Z3946
Operating handle	003Z4652
Drain connection, ½" thread	003Z4096
Drain connection, ¾" thread	003Z4097
Flow measuring instrument PFM 5001 (10 bar)	003L8343
Flow measuring instrument PFM 5001 (20 bar)	003L8344
Identification tag & strips, 10 pcs.	003Z4660
MSV-BD insulation, DN 15	003Z4781
MSV-BD insulation, DN 20	003Z4782
MSV-BD insulation, DN 25	003Z4783
MSV-BD insulation, DN 32	003Z4784
MSV-BD insulation, DN 40	003Z4785
MSV-BD insulation, DN 50	003Z4786

**Compression fittings for valves with external thread**

Pipe (mm)	Valve thread	PEX fittings, code no.	Alupex fittings, code no.
12 x 1.1	G ¾	013G4150	
12 x 2	G ¾	013G4152	013G4182
13 x 2	G ¾	013G4153	
14 x 2	G ¾	013G4154	013G4184
15 x 1.7	G ¾	013G4165	
15 x 2.5	G ¾	013G4155	013G4185
16 x 1.5	G ¾	013G4157	
16 x 2	G ¾	013G4156	013G4186
16 x 2.25	G ¾		013G4187
17 x 2	G ¾	013G4162	
18 x 2	G ¾	013G4158	013G4188
18 x 2.5	G ¾	013G4159	
20 x 2	G ¾	013G4160	013G4190
20 x 2.5	G ¾	013G4161	013G4191

**Compression fittings for valves with external thread**

Steel/copper pipes	Dimension	Code no.
	G ¾ x 15	013G4125
	G ¾ x 16	013G4126
	G ¾ x 18	013G4128
	G 1 x 18	013U0134
	G 1 x 22	013U0135

Design

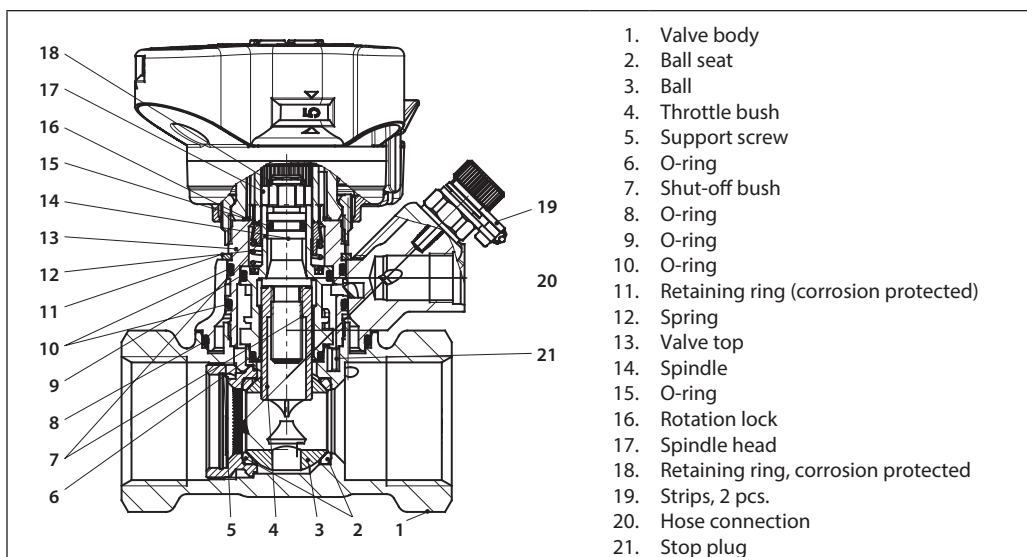

Materials and parts in contact with water	
Valve body	DZR brass
O-rings	EPDM
Ball	Brass/chromium plated
Ball sealing	Teflon

Technical data

Max. static working pressure	20 bar
Static test pressure	30 bar
Max. differential pressure across valve	2.5 bar (250 kPa)
Max. flow temperature	120 °C
Min. temperature	-20 °C
Cooling liquids	Ethylene glycol / propylene glycol and HYCOOL (max. 30 %)

Fitting

Before fitting the valve the installer must ensure that the pipe system is clean and:

1. the valve can be turned 360 degrees (if threaded pipe is used).
2. the valve is fitted according to the flow direction arrow.

Removal of the handle

1. Set the handle at 0.0.
2. Release the setting lock (green).
3. Unscrew the union nut.

Calibration of the handle

Before refitting, ensure that the handle setting is 0.0.

For DN 15 - 20 valves with external thread

Danfoss offers a complete range of compression fittings for steel, copper and PEX pipes.

DN	R1/R2 (mm)
15	86/67
20	89/69
25	91/71
32	118/84
40	118/84
50	124/90

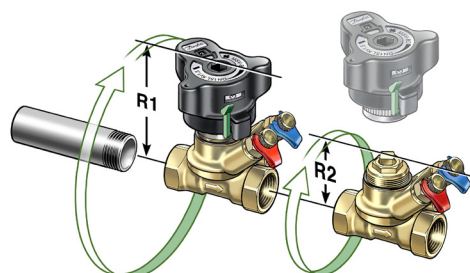

**Shut-off**

In order to shut-off the valve the handle must be pressed down.

The shut-off function features a ball valve, which only requires a 90 degree turn to shut the valve completely.

An indicator window shows the actual setting:

- red = closed
- white = open

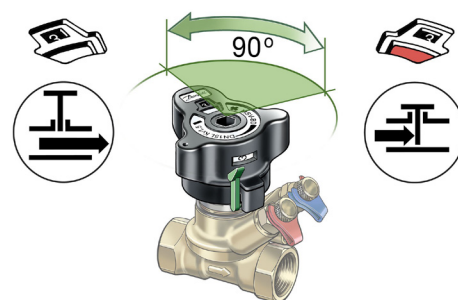

**Draining**

**Note!**

*The drain connection is an accessory and must be purchased separately.*

The drain tap can rotate 360 degrees for convenient operation.

Draining the system pipes can be done selectively: When the red test plug is opened, the valve inlet pipe is drained.

Opening the blue test plug will drain the pipe on the valve outlet side.

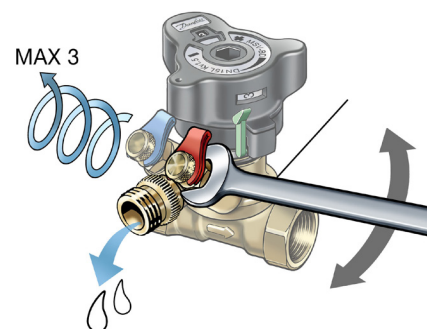

**Setting and sealing**

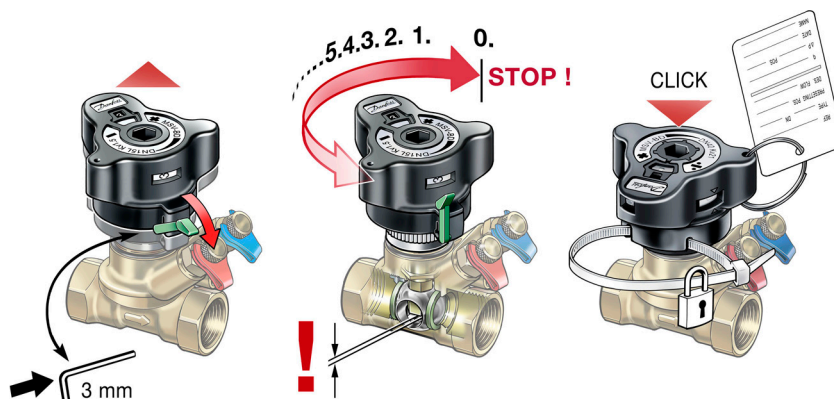

The valve has a presetting feature for setting/adjusting flow ratings.

Setting the required flow is made in 5 steps:

1. In open position, release the lock using the green lever or a 3 mm Allen key.
2. The handle pops up automatically.
3. The calculated value can now be set.
4. The setting is locked when the handle is pressed to click.
5. The setting can be sealed by using a strip as shown.

**Measuring**

The flow through the LENO™ MSV-BD valve can be measured using Danfoss PFM 5001 or other brands of measuring instruments. The LENO™ MSV-BD valve is supplied with two test plugs for Ø3 mm needles. A twin bracket enables the user to connect both needles simultaneously.

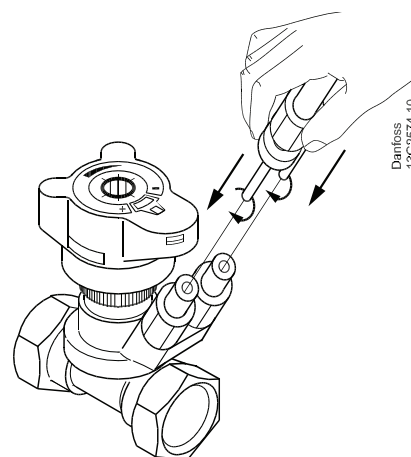

Procedure for flow measuring:

1. Select flow measuring.
2. Select valve brand.
3. Select valve type and dimension.
4. Enter presetting.
5. Connect valve and instrument.
6. Calibrate static pressure.
7. Measure the flow.

**Measuring accuracy**

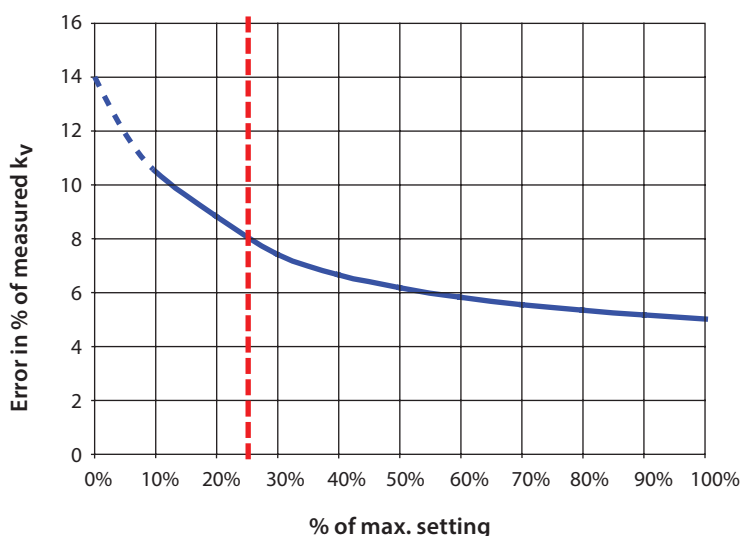

LENO™ MSV-BD is very accurate, due to the separate functions for presetting and shut-off.

The red line indicates 25% of max. flow.

According to BS7350:1990 flow rates must be within following values:

- ± 18% at 25% open position
- ± 10% at fully open position

**Kv-signal**

kv-signal values are used for non-Danfoss measuring instruments. Danfoss PFM 5001 have all data in memory, and the instruments are using this formula:

$$\Delta P_{val} = \Delta P_{sig} \left( \frac{k_{v-sig}}{k_{v-val}} \right)^2$$

Δp across the test plugs (kv-sig) and Δp across the valve (kv-val) is not the same due to turbulence influence for pressure measuring.

Kv-signal values

Setting	DN 15LF	DN 15	DN 20	DN 25	DN 32	DN 40	DN 50
0.0	0.07	0.10	0.12	0.34	0.51	1.05	1.75
0.1	0.08	0.11	0.16	0.44	0.73	1.20	2.01
0.2	0.09	0.12	0.20	0.53	0.92	1.36	2.25
0.3	0.11	0.13	0.26	0.61	1.10	1.55	2.47
0.4	0.12	0.14	0.32	0.67	1.26	1.74	2.69
0.5	0.13	0.16	0.38	0.73	1.43	1.95	2.91
0.6	0.15	0.19	0.45	0.79	1.60	2.17	3.12
0.7	0.16	0.21	0.53	0.84	1.78	2.40	3.35
0.8	0.17	0.24	0.60	0.90	1.97	2.64	3.58
0.9	0.19	0.26	0.67	0.95	2.18	2.88	3.82
1.0	0.20	0.29	0.74	1.01	2.39	3.13	4.07
1.1	0.21	0.32	0.82	1.08	2.62	3.39	4.33
1.2	0.23	0.34	0.89	1.14	2.87	3.64	4.60
1.3	0.25	0.37	0.96	1.22	3.12	3.90	4.89
1.4	0.27	0.40	1.03	1.29	3.38	4.16	5.18
1.5	0.30	0.44	1.09	1.37	3.64	4.43	5.49
1.6	0.32	0.47	1.16	1.46	3.92	4.69	5.80
1.7	0.35	0.51	1.23	1.55	4.19	4.96	6.13
1.8	0.37	0.54	1.30	1.65	4.48	5.24	6.46
1.9	0.40	0.58	1.38	1.75	4.76	5.51	6.80
2.0	0.43	0.61	1.45	1.85	5.05	5.80	7.14
2.1	0.46	0.65	1.53	1.96	5.35	6.08	7.49
2.2	0.49	0.69	1.61	2.07	5.65	6.38	7.84
2.3	0.52	0.73	1.69	2.18	5.96	6.68	8.19
2.4	0.56	0.77	1.78	2.29	6.27	6.99	8.55
2.5	0.59	0.80	1.87	2.41	6.60	7.30	8.91
2.6	0.62	0.85	1.97	2.53	6.94	7.63	9.27
2.7	0.66	0.89	2.07	2.65	7.29	7.98	9.64
2.8	0.69	0.93	2.17	2.77	7.67	8.33	10.00
2.9	0.73	0.97	2.29	2.89	8.06	8.70	10.37
3.0	0.76	1.01	2.40	3.01	8.48	9.08	10.74
3.1	0.80	1.04	2.52	3.13	8.92	9.48	11.11
3.2	0.83	1.08	2.65	3.25	9.38	9.90	11.49
3.3	0.87	1.12	2.78	3.37	9.87	10.33	11.88
3.4	0.90	1.16	2.91	3.49	10.38	10.79	12.27
3.5	0.94	1.20	3.05	3.62	10.91	11.26	12.67
3.6	0.97	1.25	3.19	3.74	11.46	11.74	13.09
3.7	1.01	1.30	3.33	3.87	12.02	12.25	13.51
3.8	1.06	1.35	3.47	4.00	12.58	12.77	13.95
3.9	1.10	1.41	3.61	4.13	13.12	13.30	14.41
4.0	1.14	1.47	3.75	4.26	13.64	13.85	14.88
4.1	1.18	1.53	3.89	4.39	14.12	14.41	15.38
4.2	1.23	1.59	4.02	4.53	14.52	14.98	15.89
4.3	1.27	1.66	4.15	4.68	14.84	15.55	16.44
4.4	1.31	1.73	4.28	4.82		16.13	17.00
4.5	1.35	1.81	4.40	4.98		16.69	17.59
4.6	1.39	1.91	4.52	5.13		17.25	18.21
4.7	1.43	2.00	4.62	5.29		17.80	18.86
4.8	1.47	2.08	4.72	5.46		18.32	19.54
4.9	1.51	2.16	4.82	5.64		18.80	20.24
5-0	1.54	2.23	4.90	5.81		19.25	20.97
5.1	1.60	2.30	4.97	6.00		19.65	21.73
5.2	1.66	2.36	5.04	6.19		19.98	22.51
5.3	1.72	2.41	5.09	6.38		20.24	23.30
5.4	1.79	2.46	5.14	6.57		20.41	24.12
5.5	1.87	2.50	5.18	6.77		20.48	24.94
5.6	1.93	2.54	5.21	6.96			25.76
5.7	1.99	2.57	5.24	7.15			26.58
5.8	2.04		5.27	7.34			27.38
5.9	2.09			7.52			28.16
6.0	2.14			7.69			28.90
6.1	2.18			7.85			29.59
6.2	2.22			7.98			30.21
6.3	2.26						30.74
6.4							31.17
6.5							31.47
6.6							31.61

Valve size and presetting

Leno™ MSV-BD

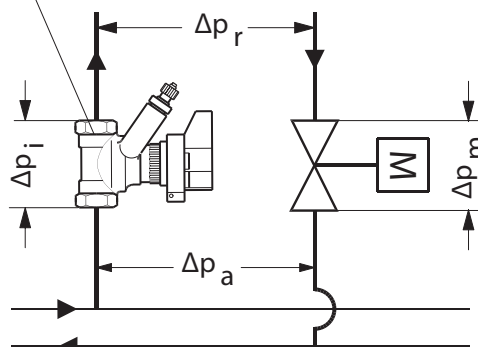

$\Delta p_i$  Pressure drop across LENO™ MSV-BD valve       $\Delta p_r$  Necessary pressure for the riser  
 $\Delta p_m$  Pressure drop across valve       $\Delta p_a$  Available pressure for the riser

**Example**

<b>Given:</b>	Max. pipe flow Q	=		2.0 m <sup>3</sup> /h
	$\Delta p_r$	=		15 kPa
	$\Delta p_a$	=		45 kPa
	$\Delta p_m$	=		10 kPa
	$\Delta p_i$	=		$\Delta p_a - \Delta p_r - \Delta p_m$
	$\Delta p_i$	=	$45 \text{ kPa} - 15 \text{ kPa} - 10 \text{ kPa}$	= 20 kPa

Correct valve size and presetting is found in the sizing and flow diagrams, pp 9.

$$Q = 2.0 \text{ m}^3/\text{h} \text{ and } \Delta p_i = 20 \text{ kPa}$$

Setting can be also calculated from the formula:

$$k_v = \frac{Q[\text{m}^3/\text{h}]}{\sqrt{\Delta p_i[\text{bar}]}} = \frac{2.0}{\sqrt{0.20}} = 4.5 \text{ m}^3/\text{h}$$



Sizing

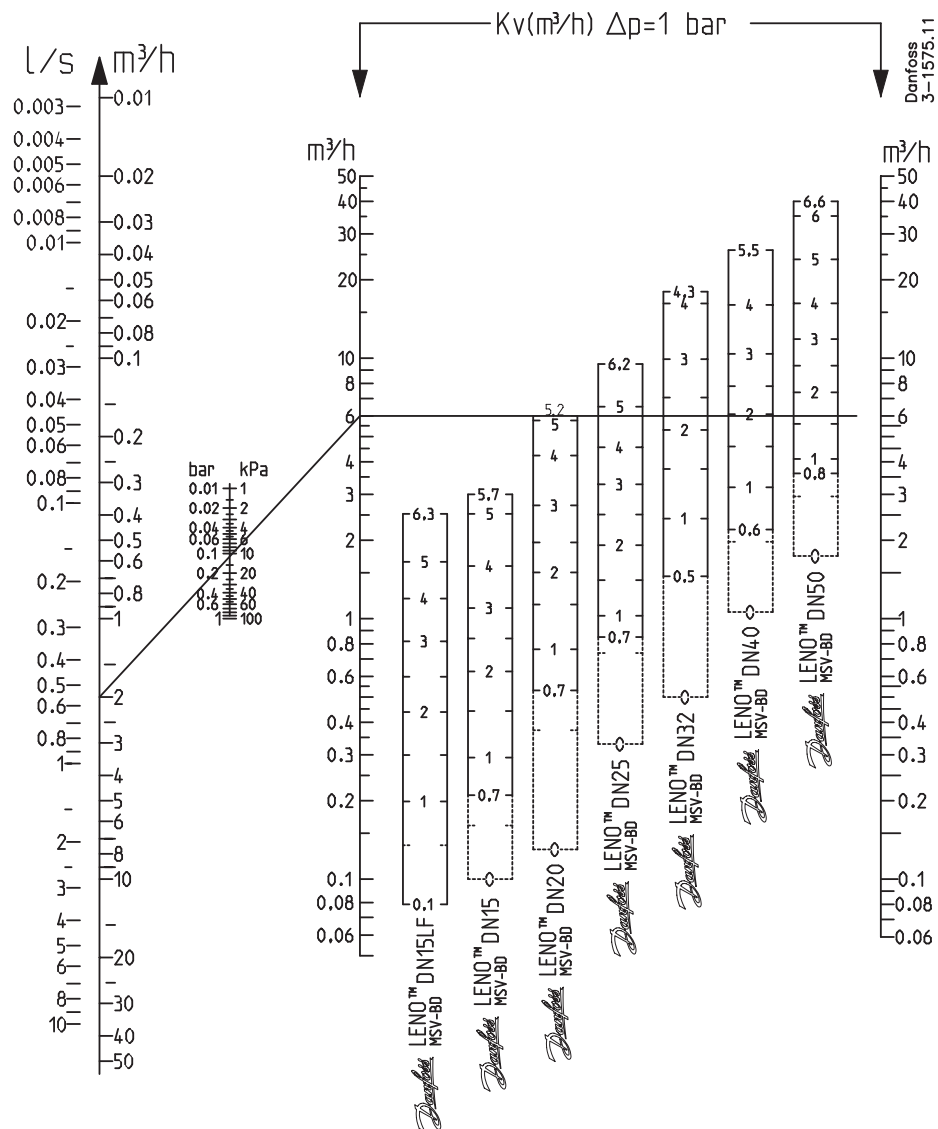

Correction factors

Medium: Ethylene glycol / propylene glycol percentage (max. 30 %).

Temp. °C	Flow, m³/h						
	25	30	40	50	60	65	100
-40.0	1)	1)	1)	1)	0.89	0.88	1)
-17.8	1)	1)	0.93	0.91	0.90	0.89	0.86
4.4	0.95	<b>0.95</b>	0.93	0.92	0.91	0.90	0.87
26.6	0.96	0.95	0.94	0.93	0.92	0.91	0.88
48.9	0.97	0.96	0.95	0.94	0.93	0.92	0.90
71.1	0.98	0.98	0.96	0.95	0.94	0.94	0.95
93.3	1.00	0.99	0.97	0.96	0.95	0.95	0.92
115.6	2)	2)	2)	2)	2)	2)	0.94

1) Below freezing point

2) Above boiling point

**Example**  
 Flow needed .....30 m³/h  
 Flow after correction ..... 30 x 0.95 = 28 m³/h

Flow diagrammes,  
DN 15 LF

LENO™ MSV-BD DN 15 LF

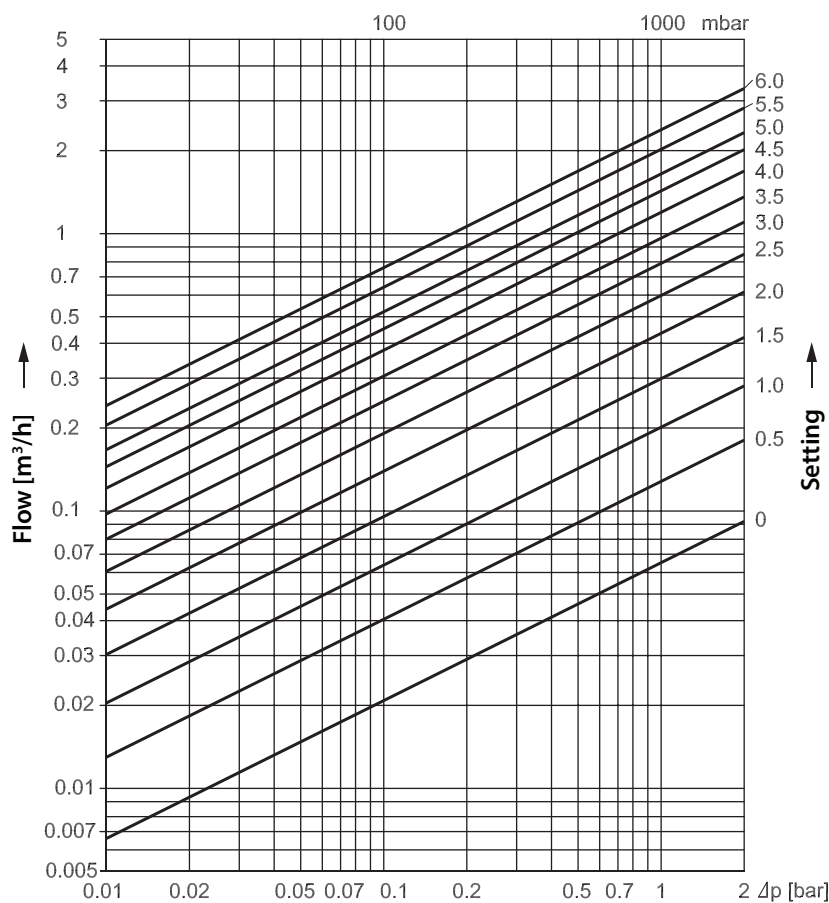

Setting	k <sub>v</sub> -value
0.0	0.07
0.1	0.08
0.2	0.09
0.3	0.11
0.4	0.12
0.5	0.13
0.6	0.15
0.7	0.16
0.8	0.17
0.9	0.19
1.0	0.20
1.1	0.22
1.2	0.23
1.3	0.25
1.4	0.28
1.5	0.30
1.6	0.32
1.7	0.35
1.8	0.38
1.9	0.41
2.0	0.44
2.1	0.47
2.2	0.50
2.3	0.53
2.4	0.56
2.5	0.60
2.6	0.63
2.7	0.67
2.8	0.71
2.9	0.74
3.0	0.78
3.1	0.82
3.2	0.86
3.3	0.89
3.4	0.93
3.5	0.97
3.6	1.01
3.7	1.05
3.8	1.10
3.9	1.15
4.0	1.19
4.1	1.24
4.2	1.29
4.3	1.33
4.4	1.38
4.5	1.43
4.6	1.48
4.7	1.52
4.8	1.56
4.9	1.61
5.0	1.65
5.1	1.72
5.2	1.78
5.3	1.86
5.4	1.94
5.5	2.03
5.6	2.10
5.7	2.17
5.8	2.23
5.9	2.30
6.0	2.36
6.1	2.42
6.2	2.47
6.3	2.53

Flow characteristics

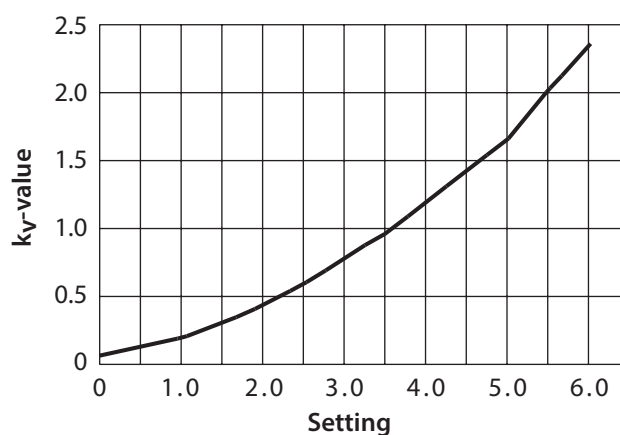

Flow diagrammes,  
DN 15

LENO™ MSV-BD DN 15

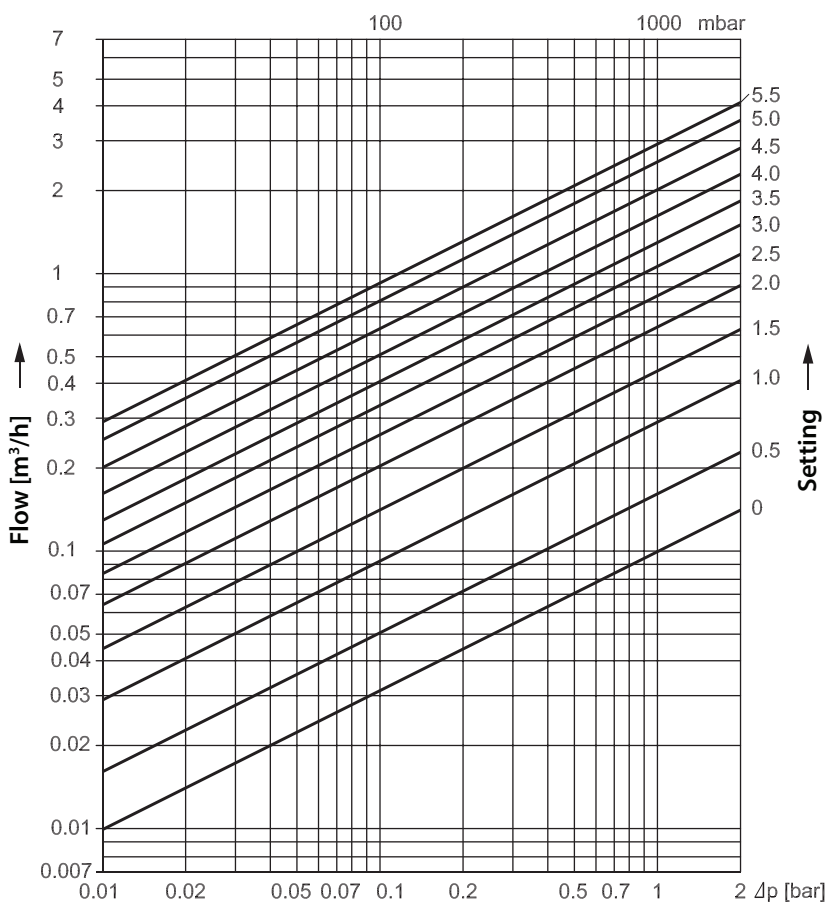

Setting	k <sub>v</sub> -value
0.0	0.10
0.1	0.11
0.2	0.12
0.3	0.13
0.4	0.14
0.5	0.16
0.6	0.19
0.7	0.21
0.8	0.24
0.9	0.27
1.0	0.29
1.1	0.32
1.2	0.35
1.3	0.38
1.4	0.41
1.5	0.44
1.6	0.48
1.7	0.51
1.8	0.55
1.9	0.59
2.0	0.63
2.1	0.67
2.2	0.71
2.3	0.75
2.4	0.80
2.5	0.84
2.6	0.88
2.7	0.93
2.8	0.97
2.9	1.02
3.0	1.06
3.1	1.10
3.2	1.14
3.3	1.19
3.4	1.23
3.5	1.28
3.6	1.34
3.7	1.40
3.8	1.46
3.9	1.52
4.0	1.59
4.1	1.66
4.2	1.74
4.3	1.82
4.4	1.91
4.5	2.00
4.6	2.12
4.7	2.23
4.8	2.33
4.9	2.43
5.0	2.53
5.1	2.61
5.2	2.70
5.3	2.77
5.4	2.84
5.5	2.90
5.6	2.95
5.7	3.00

Flow characteristics

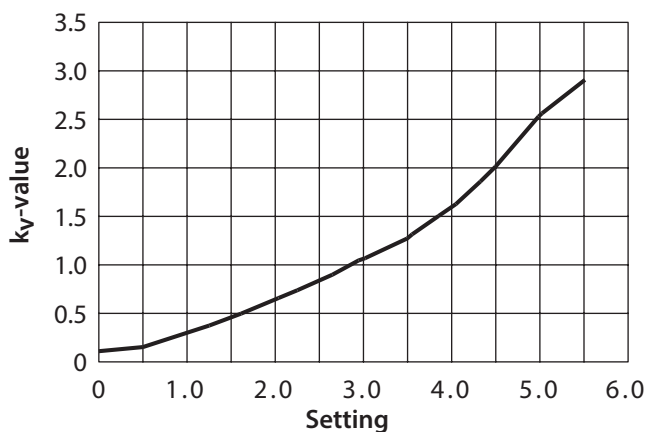

Flow diagrammes,  
DN 20

LENO™ MSV-BD DN 20

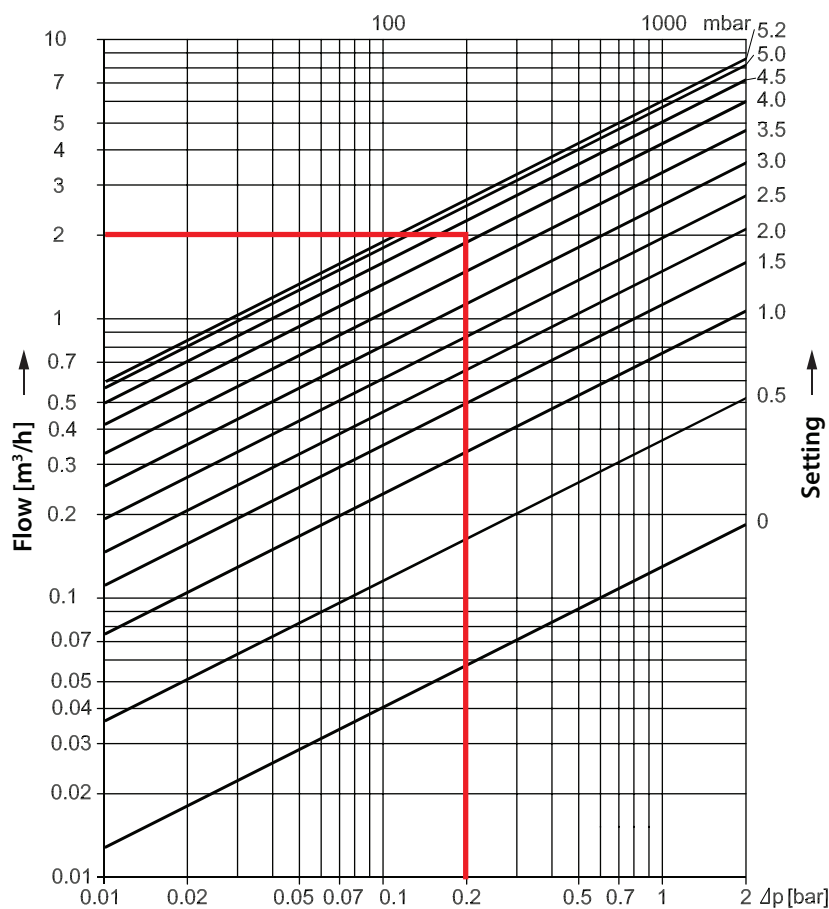

Setting	$k_V$ -value
0.0	0.13
0.1	0.15
0.2	0.19
0.3	0.24
0.4	0.30
0.5	0.37
0.6	0.45
0.7	0.53
0.8	0.61
0.9	0.68
1.0	0.76
1.1	0.84
1.2	0.92
1.3	0.99
1.4	1.06
1.5	1.13
1.6	1.21
1.7	1.28
1.8	1.35
1.9	1.43
2.0	1.50
2.1	1.59
2.2	1.67
2.3	1.76
2.4	1.86
2.5	1.96
2.6	2.07
2.7	2.19
2.8	2.31
2.9	2.44
3.0	2.58
3.1	2.72
3.2	2.87
3.3	3.03
3.4	3.19
3.5	3.36
3.6	3.53
3.7	3.70
3.8	3.87
3.9	4.05
4.0	4.23
4.1	4.40
4.2	4.58
4.3	4.75
4.4	4.91
4.5	5.07
4.6	5.22
4.7	5.37
4.8	5.51
4.9	5.64
5.0	5.77
5.1	5.88
5.2	6.00
5.3	6.09
5.4	6.19
5.5	6.29
5.6	6.39
5.7	6.49
5.8	6.60

Flow characteristics

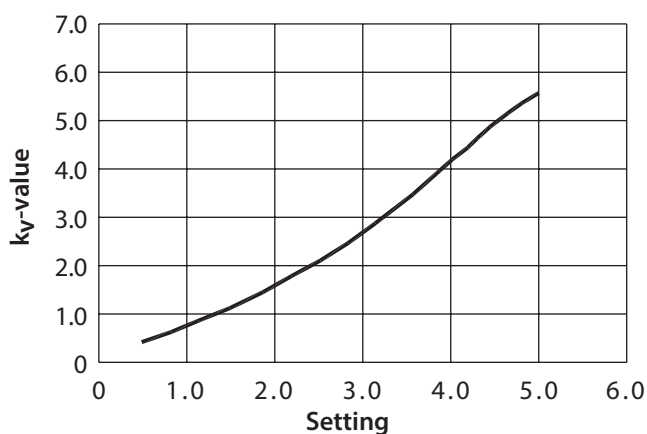

Flow diagrammes,  
DN 25

LENO™ MSV-BD DN 25

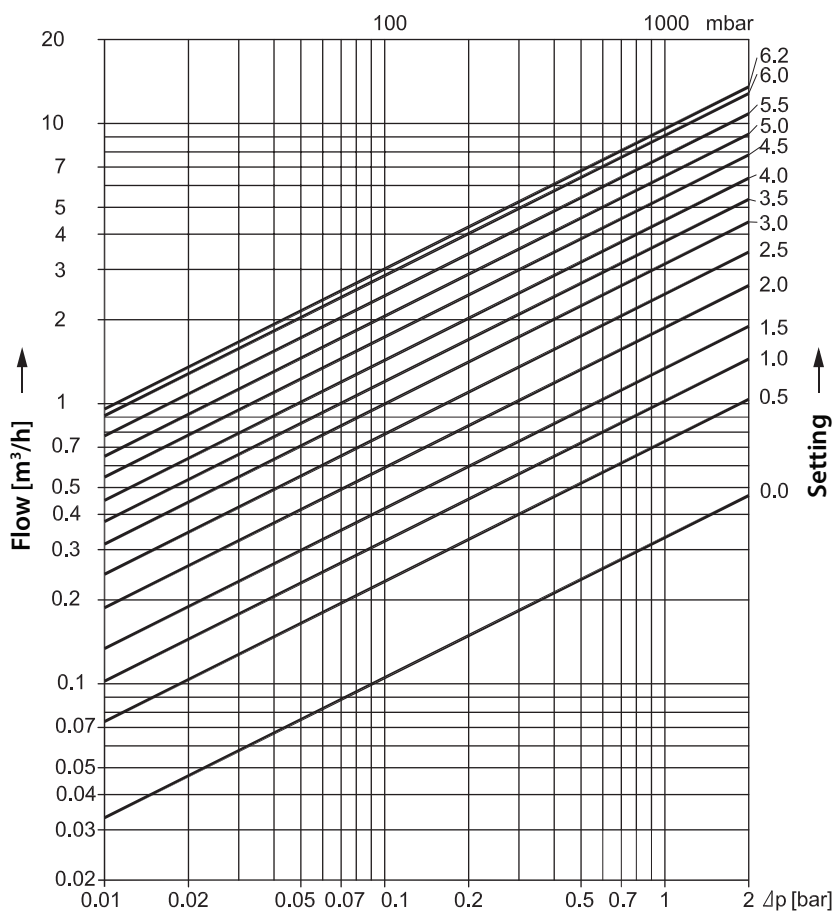

Setting	k <sub>v</sub> -value
0.0	0.33
0.1	0.44
0.2	0.53
0.3	0.61
0.4	0.68
0.5	0.74
0.6	0.79
0.7	0.85
0.8	0.91
0.9	0.96
1.0	1.03
1.1	1.09
1.2	1.16
1.3	1.24
1.4	1.32
1.5	1.41
1.6	1.50
1.7	1.60
1.8	1.70
1.9	1.80
2.0	1.91
2.1	2.03
2.2	2.15
2.3	2.26
2.4	2.39
2.5	2.51
2.6	2.64
2.7	2.76
2.8	2.89
2.9	3.02
3.0	3.15
3.1	3.28
3.2	3.41
3.3	3.54
3.4	3.68
3.5	3.81
3.6	3.95
3.7	4.09
3.8	4.24
3.9	4.39
4.0	4.55
4.1	4.71
4.2	4.88
4.3	5.05
4.4	5.23
4.5	5.42
4.6	5.62
4.7	5.83
4.8	6.05
4.9	6.27
5.0	6.51
5.1	6.75
5.2	7.00
5.3	7.26
5.4	7.53
5.5	7.80
5.6	8.06
5.7	8.33
5.8	8.59
5.9	8.84
6.0	9.08
6.1	9.30
6.2	9.50

Flow characteristics

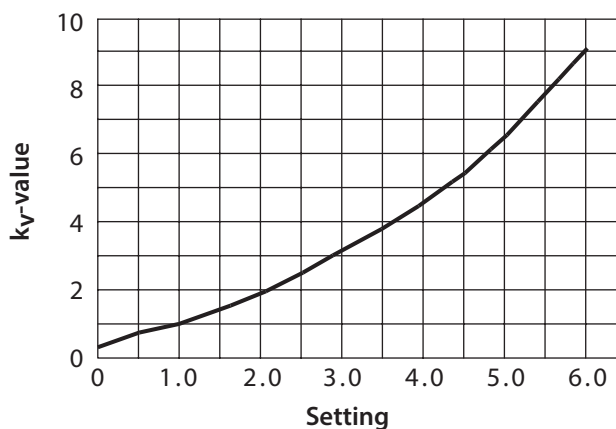

Flow diagrammes,  
DN 32

LENO™ MSV-BD DN 32

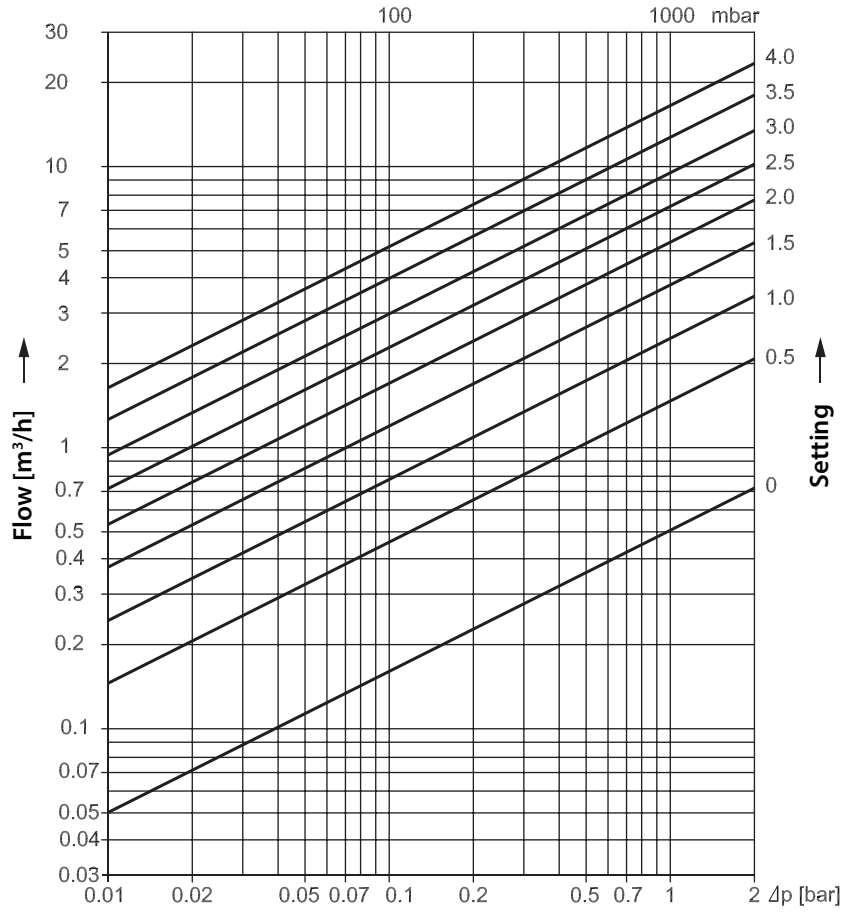

Setting	k <sub>v</sub> -value
0.0	0.50
0.1	0.75
0.2	0.95
0.3	1.13
0.4	1.29
0.5	1.45
0.6	1.62
0.7	1.80
0.8	1.99
0.9	2.20
1.0	2.42
1.1	2.66
1.2	2.92
1.3	3.19
1.4	3.47
1.5	3.75
1.6	4.05
1.7	4.36
1.8	4.67
1.9	4.98
2.0	5.30
2.1	5.63
2.2	5.97
2.3	6.32
2.4	6.68
2.5	7.06
2.6	7.46
2.7	7.89
2.8	8.34
2.9	8.83
3.0	9.35
3.1	9.92
3.2	10.52
3.3	11.16
3.4	11.85
3.5	12.51
3.6	13.23
3.7	13.98
3.8	14.74
3.9	15.49
4.0	16.23
4.1	16.91
4.2	17.51
4.3	18.00

Flow characteristics

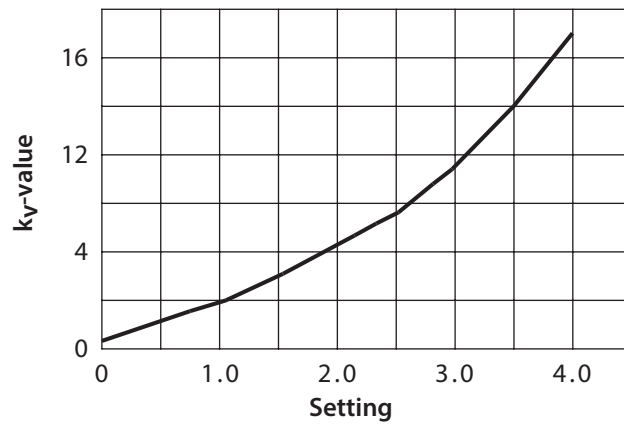

Flow diagrammes,  
DN 40

LENO™ MSV-BD DN 40

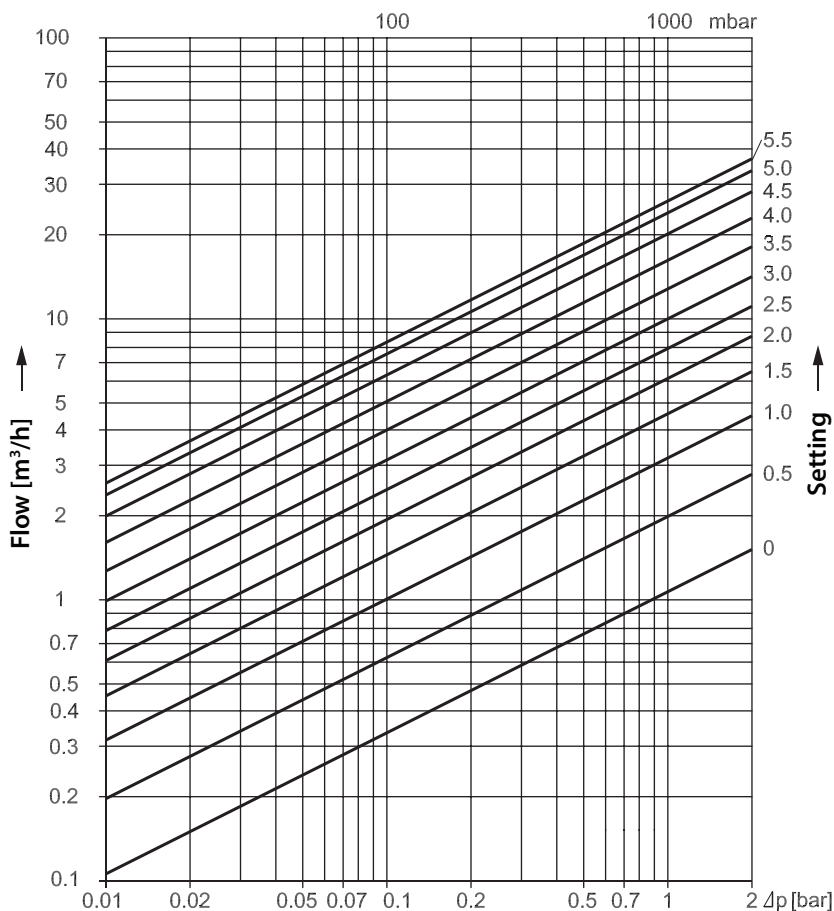

Setting	k <sub>v</sub> -value
0.0	1.06
0.1	1.21
0.2	1.38
0.3	1.56
0.4	1.76
0.5	1.97
0.6	2.20
0.7	2.43
0.8	2.68
0.9	2.93
1.0	3.19
1.1	3.46
1.2	3.73
1.3	4.01
1.4	4.29
1.5	4.58
1.6	4.87
1.7	5.17
1.8	5.47
1.9	5.78
2.0	6.09
2.1	6.41
2.2	6.74
2.3	7.09
2.4	7.44
2.5	7.80
2.6	8.18
2.7	8.58
2.8	9.00
2.9	9.44
3.0	9.90
3.1	10.38
3.2	10.89
3.3	11.43
3.4	12.00
3.5	12.60
3.6	13.22
3.7	13.88
3.8	14.56
3.9	15.28
4.0	16.02
4.1	16.79
4.2	17.57
4.3	18.38
4.4	19.19
4.5	20.02
4.6	20.82
4.7	21.61
4.8	22.38
4.9	23.12
5.0	23.81
5.1	24.44
5.2	25.00
5.3	25.46
5.4	25.80
5.5	26.00

Flow characteristics

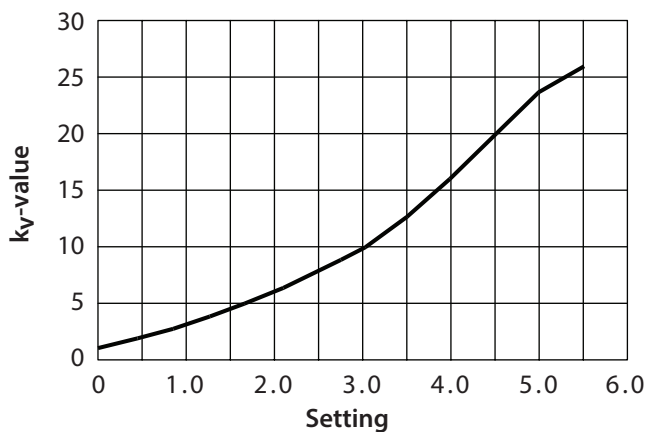

Flow diagrammes,  
DN 50

LENO™ MSV-BD DN 50

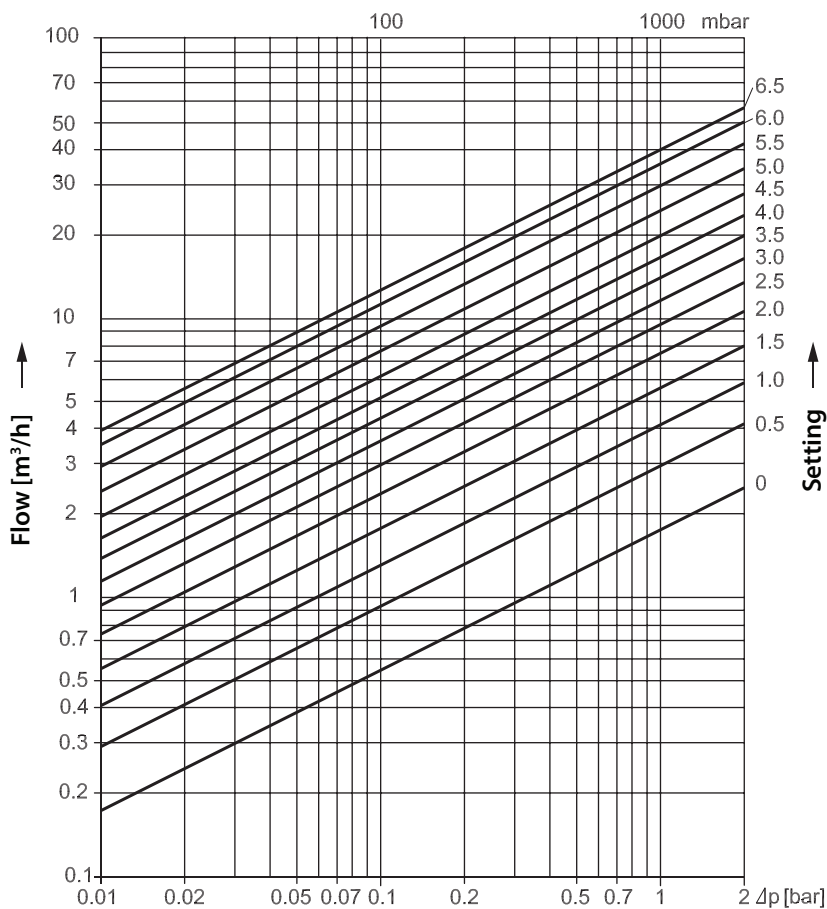

Setting	k <sub>v</sub> -value
0.0	1.74
0.1	2.03
0.2	2.28
0.3	2.51
0.4	2.73
0.5	2.95
0.6	3.16
0.7	3.38
0.8	3.61
0.9	3.85
1.0	4.10
1.1	4.37
1.2	4.65
1.3	4.95
1.4	5.26
1.5	5.59
1.6	5.93
1.7	6.28
1.8	6.64
1.9	7.01
2.0	7.39
2.1	7.78
2.2	8.17
2.3	8.56
2.4	8.96
2.5	9.36
2.6	9.76
2.7	10.17
2.8	10.58
2.9	10.99
3.0	11.41
3.1	11.84
3.2	12.27
3.3	12.71
3.4	13.16
3.5	13.62
3.6	14.10
3.7	14.60
3.8	15.12
3.9	15.66
4.0	16.23
4.1	16.84
4.2	17.47
4.3	18.14
4.4	18.84
4.5	19.59
4.6	20.38
4.7	21.21
4.8	22.08
4.9	23.00
5.0	23.96
5.1	24.96
5.2	26.00
5.3	27.07
5.4	28.17
5.5	29.30
5.6	30.44
5.7	31.64
5.8	32.83
5.9	34.01
6.0	35.14
6.1	36.23
6.2	37.24
6.3	38.14
6.4	38.93
6.5	39.56
6.6	40.00

Flow characteristics

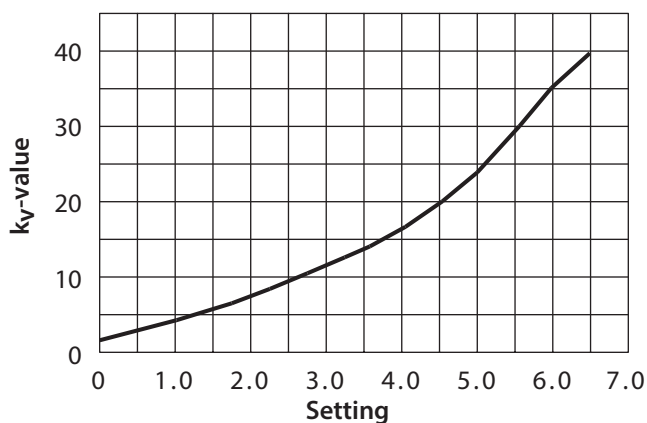



Dimensions

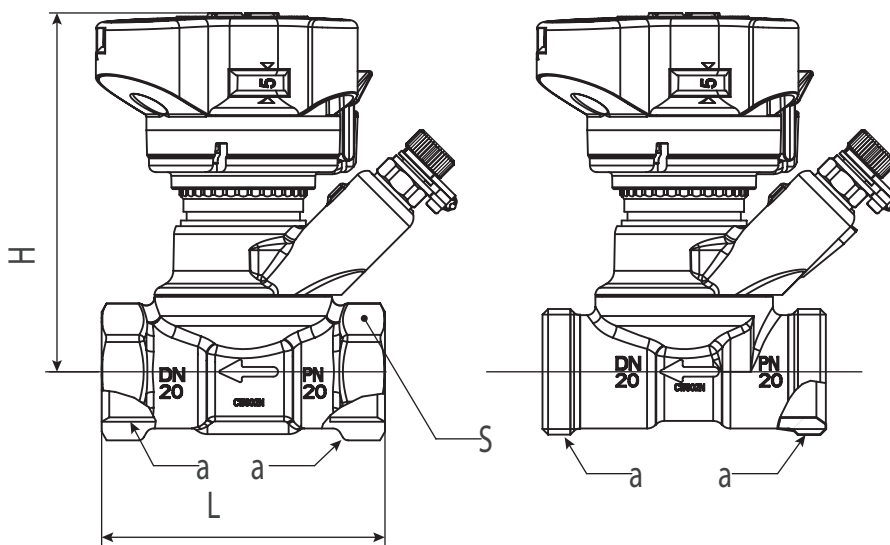

MSV-BD	Size	a Thread ISO 228-1	L (mm)	H (mm)	S (mm)
003Z4000	DN 15 LF	G ½	65	92	27
003Z4001	DN 15	G ½	65	92	27
003Z4002	DN 20	G ¾	75	95	32
003Z4003	DN 25	G 1	85	98	41
003Z4004	DN 32	G 1¼	98	121	50
003Z4005	DN 40	G 1½	100	125	55
003Z4006	DN 50	G 2	130	129	67
003Z4100	DN 15 LF	G ¾ A	70	92	-
003Z4101	DN 15	G ¾	70	92	-
003Z4102	DN 20	G 1 A	75	95	-

Tender specifications

LENO™ MSV-BD can be used in heating, cooling and domestic hot water systems.

Features	LENO™ MSV-BD
Balancing / Commissioning	•
Presetting	•
Fixed orifice	
Self sealing test plugs	•
Digital visible scale from more sides	•
Shut-off function (ball valve)	•
Draining / filling	•
Draining / filling on both sides of the valve	•
Removable handle	•
Closing indicator	•
Allen key for ball valve	•
Parallel test plugs	•
360° rotating measuring station (drain tap and test plugs)	•

Presetting values are visible on top of the valve and from all sides.

Presetting is locked by pressing down the handle. When locked, the shut-off function can be used without changing the presetting.

The handle is released with the green key or with a 3 mm Allen key.

To prevent unintended changes of the presetting, the handle can be sealed by using a strip.

The system can be drained and filled on both sides of the ball valve.

External thread versions comes in sizes DN 15 and DN 20 and are prepared for Danfoss standard fittings. DN 15 is designed with Euro cone, according to DIN V 3838.

LENO™ MSV-BD has a leakage rate A according to ISO 5208, the ball valve is 100% tight.

The LENO™ MSV-BD measuring accuracy is 8% at 25% of max. setting.

Accuracy is according to BS 7350 : 1990.

Measuring instruments must be equipped with Ø3 mm measuring needles. Danfoss measuring instruments PFM 5001 contain all relevant valve data.

Valve sizes ..... DN 15 (LF) – DN 50

Pressure class ..... PN20

Static test pressure ..... 30 bar

Working temperature ..... -20°C to 120°C

Working area ..... 10-100% of the  $k_{VS}$ -value

The valve body is made of DZR brass.

The ball is made of chromium plated brass.

O-rings are made from EPDM rubber.



