

TG.09.0113

Specification

Part No.	TG.09.0113
Product Name	Penta-band Cellular Hinged SMA Male Monopole
Feature	<ul style="list-style-type: none"> 800 MHz to 2200MHz GSM/CDMA/HSPA/UMTS Rotatable hinge design for optimal reception Top quality housing with brass hinge and connector Extended operation temperature range RoHS Compliant

1. Introduction

The TG.09 Penta-band Cellular Hinged Rotatable SMA antenna is a high efficiency monopole antenna. Compared to other much larger antennas on the market, it has superior wide-band high efficiency characteristics.

This antenna is used by many of the leading wireless device providers in the world marketplace.

The unique rotatable hinge design enables the user to rotate the antenna to the best angle for an optimal cellular signal reception. As the upper antenna element can move in any direction, it also reduces damage from impact force from any angle to the antenna, compared to traditional hinged right angle or fixed right angle designs or straight antennas.

The tiny dimensions of this antenna coupled with excellent RF performance and an aesthetic high end design feel make it the ideal cellular antenna for routers, vehicle tracking devices, telematics devices, remote monitoring systems, POS devices.

The TG.09 as all monopole antennas works best connected directly to the ground-plane of the device main-board. Taoglas offers support services to characterize antenna efficiency on your individual device ground-plane.

Please contact Taoglas regional support centre first if you wish to do PTCRB or network approvals with this antenna attached to your device, so we can check RF integration is correct and do

a pre-test first to ensure optimized passive and active performance and a smooth and quick certification approval process.

This antenna also comes in a white version.

[TG.09.0113W](#)

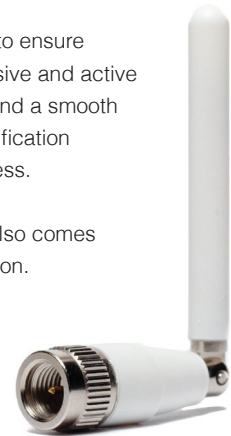

If your device does not have a direct connection to ground-plane, please consider using our [TG.30 Apex Wideband Dipole Cellular Antenna](#), which does not need a ground-plane to connect to.

2. Specification

Electrical

Communication System	Penta-band Cellular				
	AMPS	GSM	DCS	PCS	UMTS
Frequency	824 ~ 896	880 ~ 960	1710 ~ 1880	1850 ~ 1990	1710 ~ 2170
Efficiency (free space)*	21%	24%	23%	32%	31%
Gain (dBi, free space)*	2.0	2.0	-1.0	-0.4	-0.1
Efficiency (mounted on PCB)*	39%	31%	78%	75%	75%
Gain (dBi, mounted on PCB)*	1.0	-1.0	2.8	2.8	2.0
Impedance	50Ω				
Polarization	Linear				
Radiation Pattern	Omni-directional				
Input Power	10 W				

Mechanical

Antenna Length	72 ± 1.5 mm
Antenna Diameter	10 ± 0.3 mm
Casing	POM
Connector	SMA Male (Brass)

Environmental

Temperature Range	-40°C to 85°C
Storage Temperature	-40°C ~ +105°C
Humidity	Non-condensing 65°C 95% RH

* Average efficiency and peak gain of antenna sitting 180° in free space and mounted at the side of the PCB. Please refer to section IV for testing detail.

3. Electrical Property – Return Loss

Return Loss measure the amount of signal energy that is reflected back to the system (the network analyzer) due to impedance mismatch between the 50ohm network analyzer and the antenna.

-3dBi means half of the energy is reflected back and -10dBi means 10% of energy is reflected back to the system.



TG.09 Return Loss

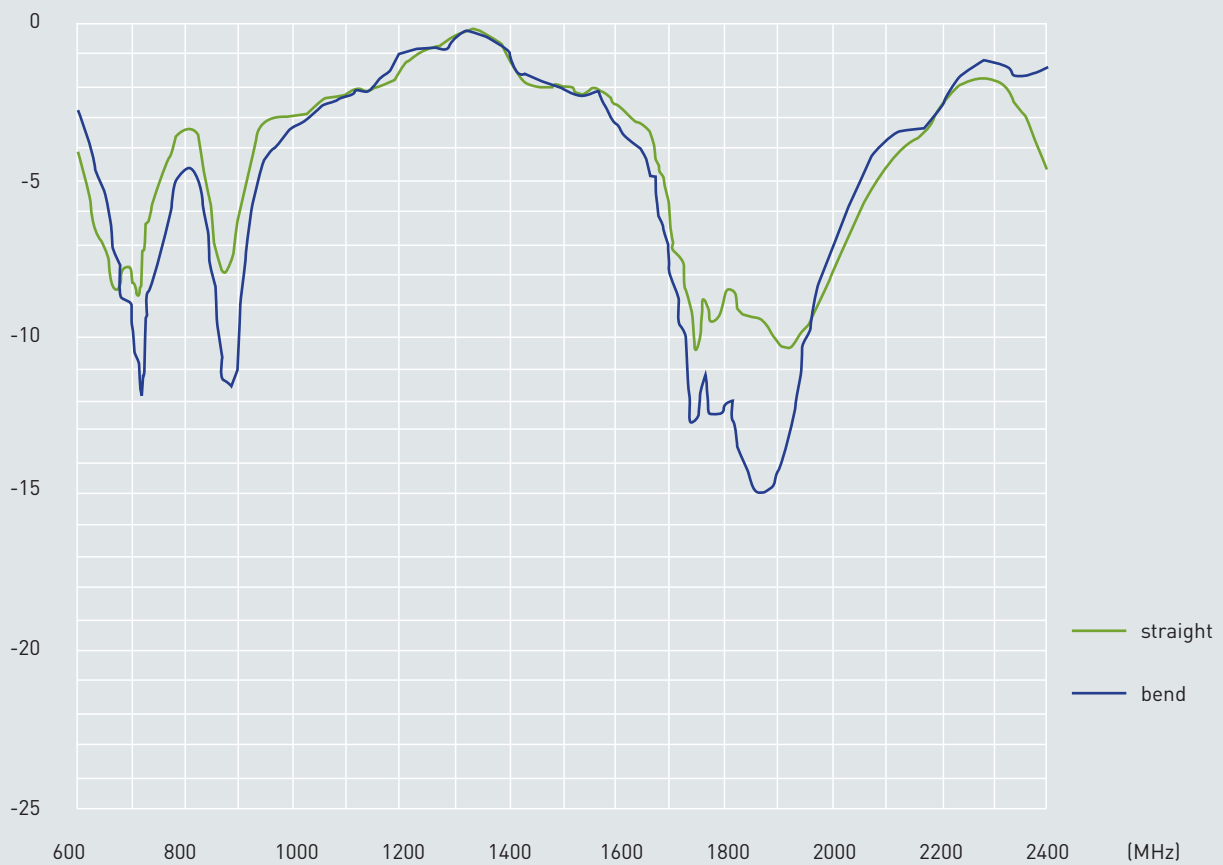

TG.09 tested with Agilent 8753ES

4. Electrical Property – Efficiency

Antenna normally behaves differently when mounting on a different environment. So we test the antenna in four different settings –

a) free space

b) on top of a 150 x 90mm ground plane.
(A common ground plane size for electronic device)

c) on the edge of a 150 x 90mm ground plane.
(Another common way of mounting antenna)

d) 450 x 350 ground plane.
This simulates the situation of mounting TG.09 on top of a large metal object, such as a vehicle.

TG.09 can be installed in 5 different angles so we present the test in different combination of angles and mounting environment.

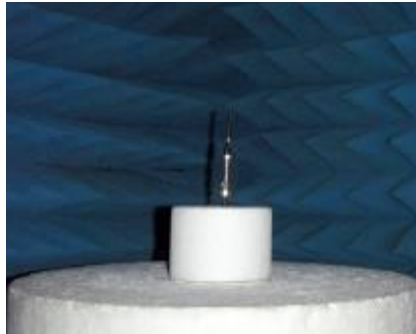

1. Free Space

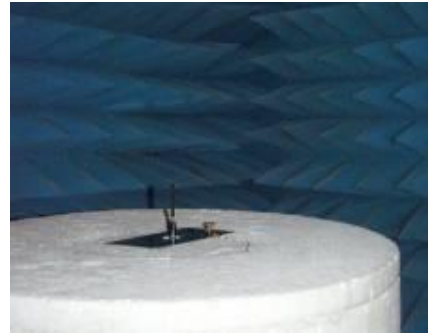

2. PCB Size Ground Plane

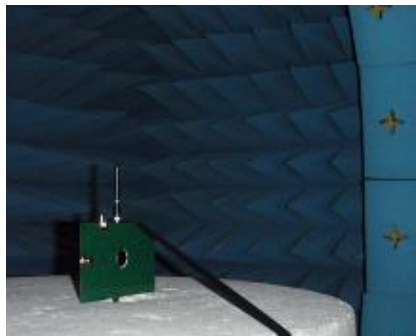

3. Mounting Upright



4. Metal Plane

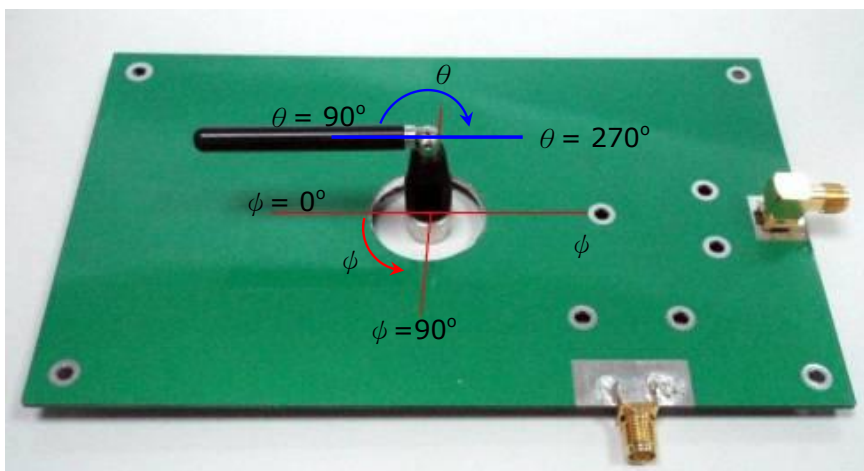

TG.09 on top of a 150 x 90mm PCB. θ is the horizontal rotation and ϕ is the vertical position of TG.09 with respect to the 3D chamber.

In the Satimo chamber, $\phi = 0$ is the x-axial, $\phi = 90^\circ$ is the y-axial and $\phi = 180^\circ$ is the z-axial.

4.1 TG.09 on Different Mounting Condition

Here we compare TG.09 in its most common installation angles (90° and 180°) with different mounting environments.

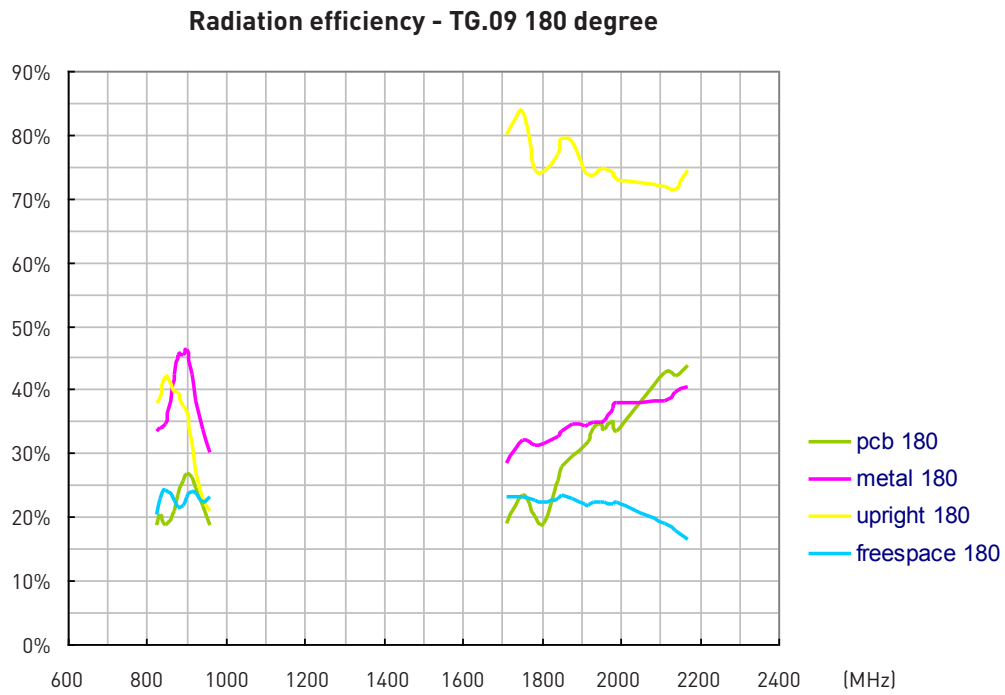

Antenna in straight position (180°) on different mounting condition.

4.1 TG.09 on Different Mounting Condition

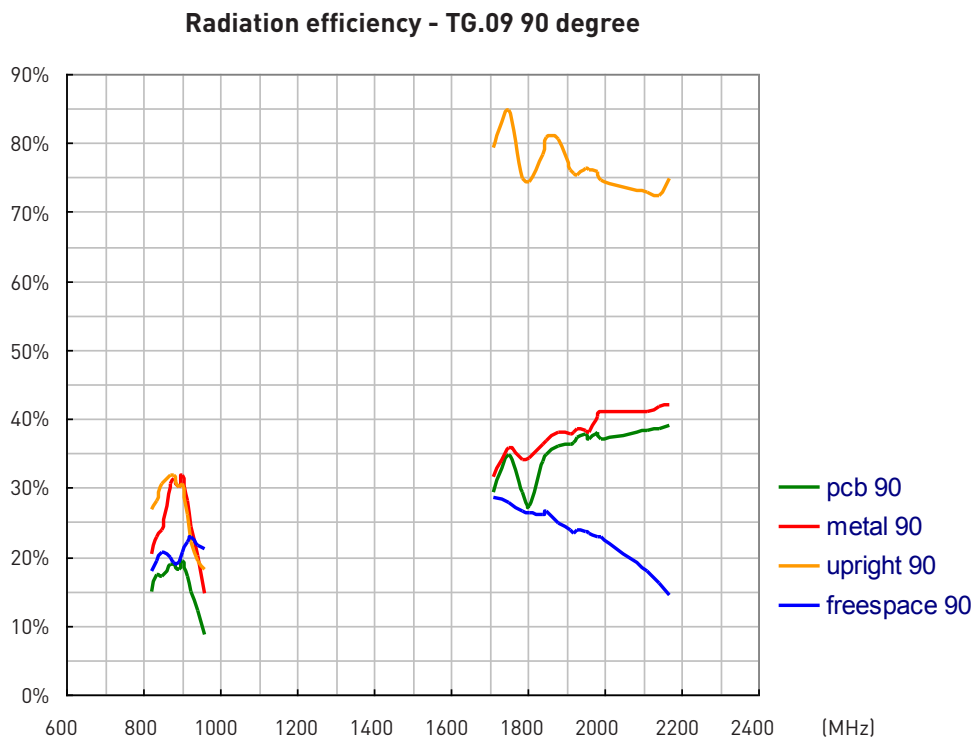

Antenna in right angle position (90°) on different mounting condition.

TG.09 is a monopole antenna. It works better with the present of a ground plane. The size of the ground plane does not affect the radiation efficiency much as long as it is greater than 1/4 wavelength (1/4 wavelength for 824MHz is 91mm).

4.2 TG.09 - Different Rotation Angle

TG.09 has 5 different locking θ angle and is free to mount at any angle around \emptyset . Different position of antenna with respect to the ground has different antenna radiation. We tested TG.09 in three common situation of antenna mounting.

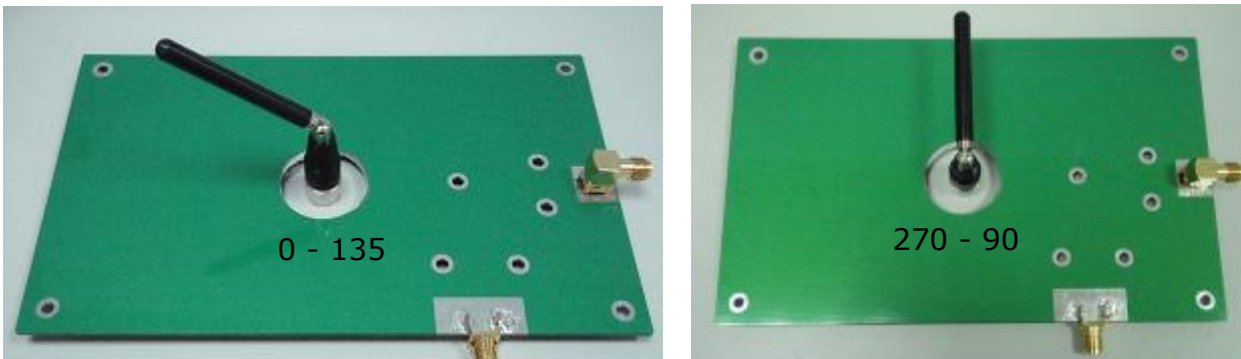

Different antenna mounting is marked as (\emptyset angle-- θ angle), photos are two example of the position marking.

TG.09 mounted on PCB ground

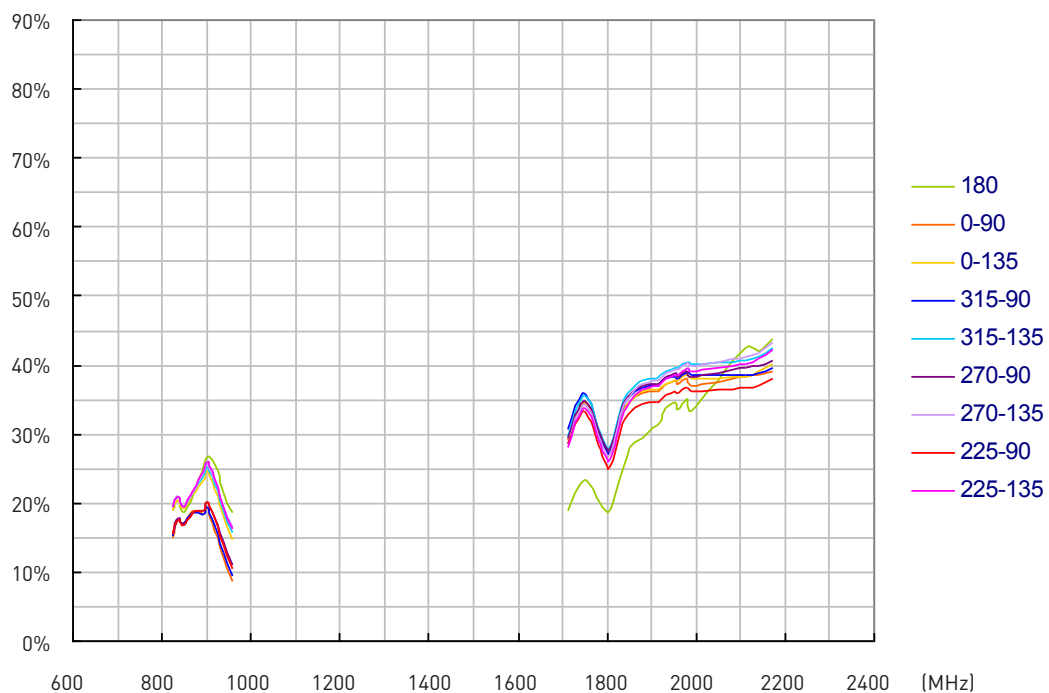

4.2 TG.09 - Different Rotation Angle

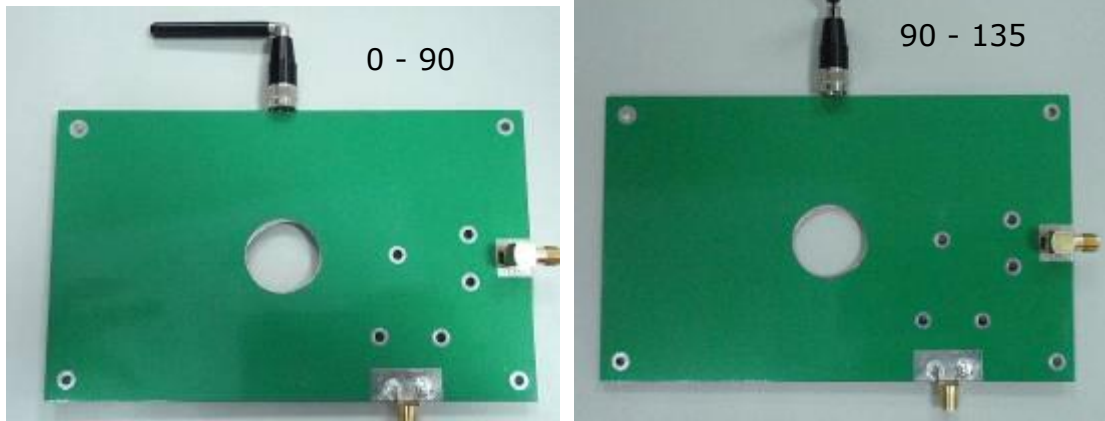

Example of upright mounting.

TG.09 mounted at the edge of PCB (upright position)

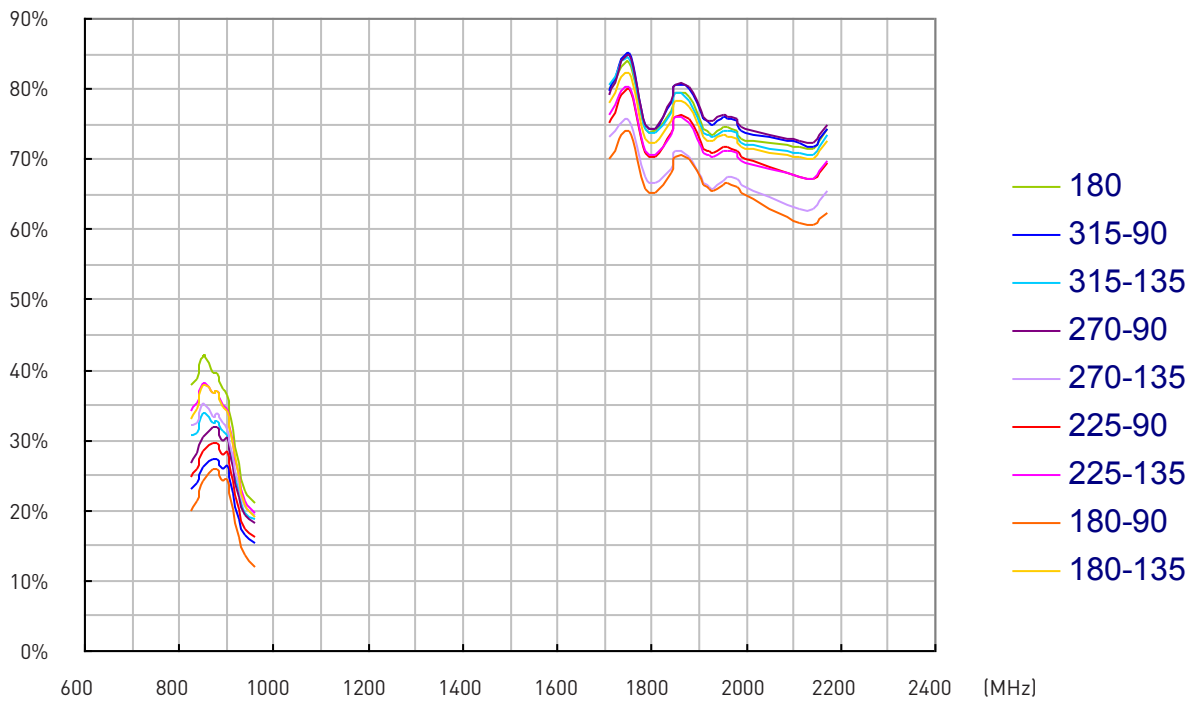

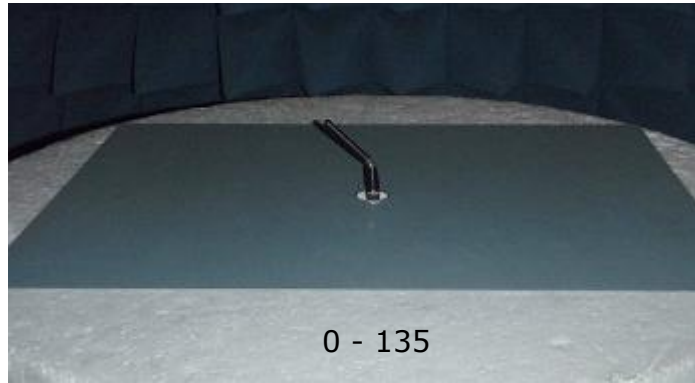

Example of TG.09 mounting on metal plane.

TG.09 mounted on metal plane



Different ground plane let TG.09 have very different efficiency distribution.
 Different TG.09 rotation for any given mounting ground has up to 20% efficiency different for each frequency, but has similar efficiency distribution.

5. Radiation Pattern

5.1 TG.09 in Free Space

Vertical

Horizontal

TG.09 180° in free space

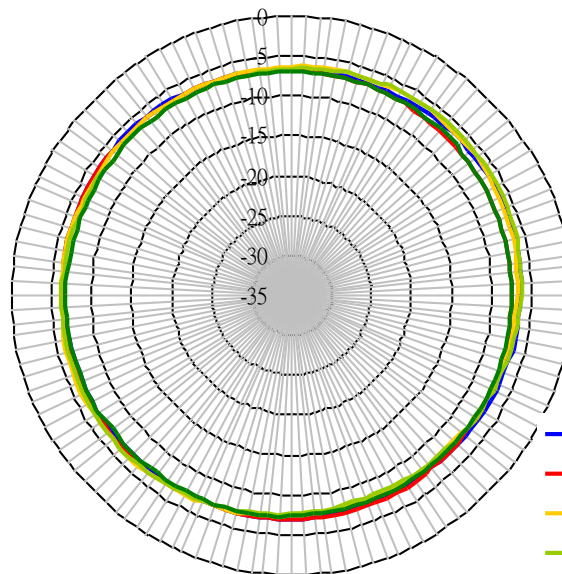
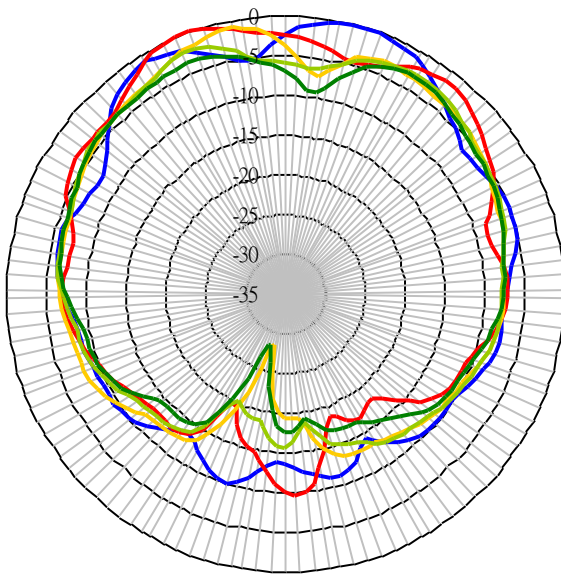

- 850MHz
- 900MHz
- 1800MHz
- 1900MHz
- 2100MHz

TG.09 90° in free space

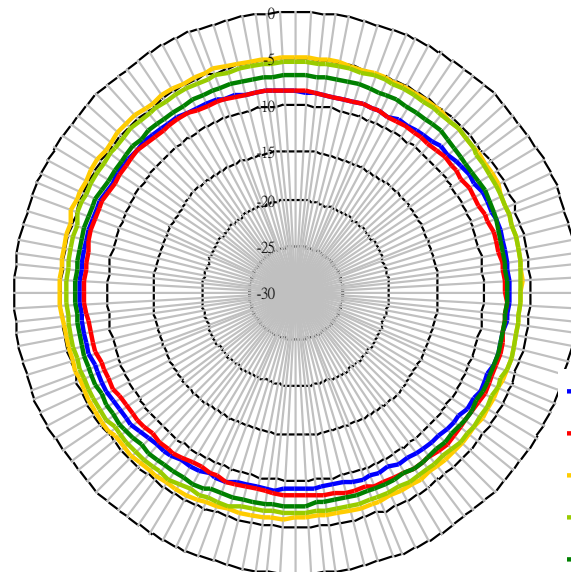
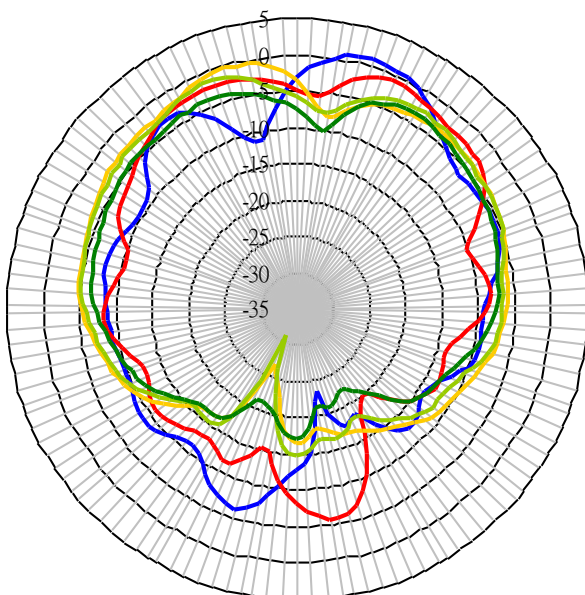

- 850MHz
- 900MHz
- 1800MHz
- 1900MHz
- 2100MHz

5.2 TG.09 Mounted on PCB

Vertical

Horizontal

TG.09 180° on PCB

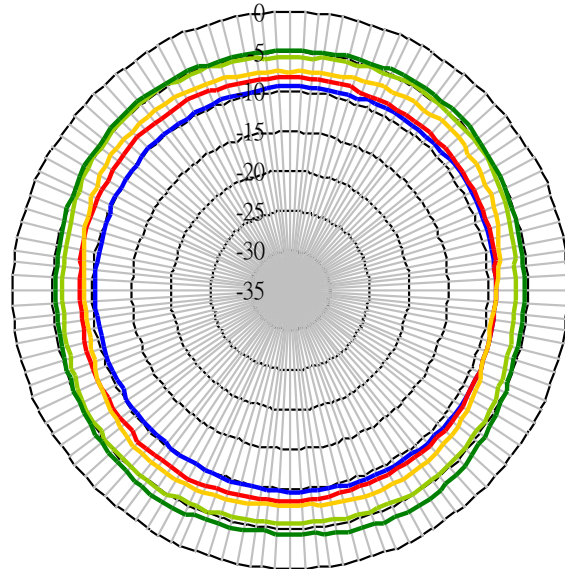
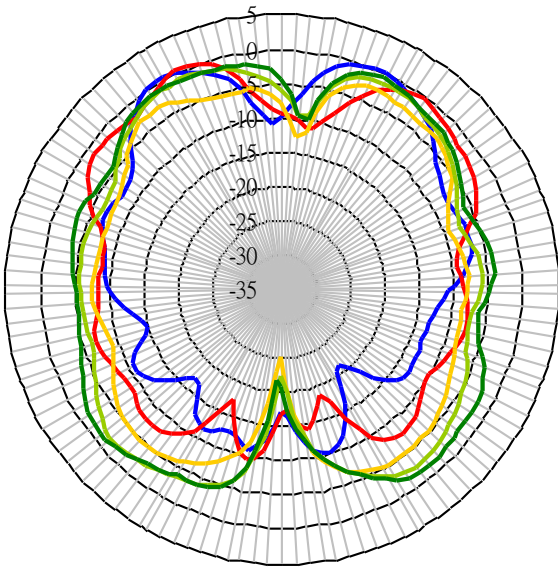

- 850MHz
- 900MHz
- 1800MHz
- 1900MHz
- 2170MHz

TG.09 90° on PCB (0-90)

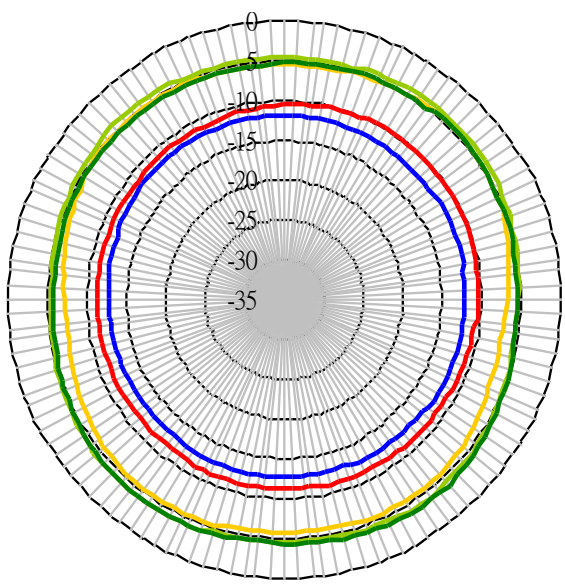
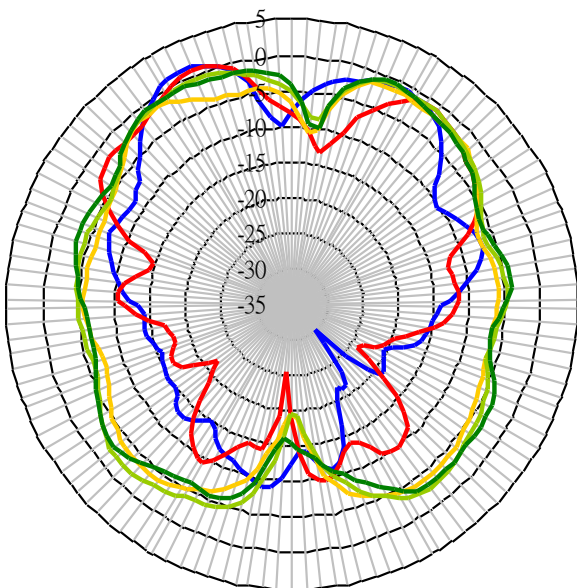

- 850MHz
- 900MHz
- 1800MHz
- 1900MHz
- 2170MHz

5.3 TG.09 Mounted At a Side of PCB

Vertical

Horizontal

TG.09 180° mounted at the side of PCB

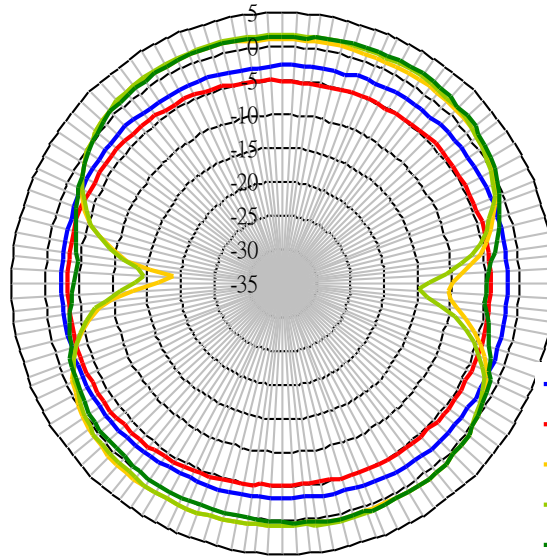
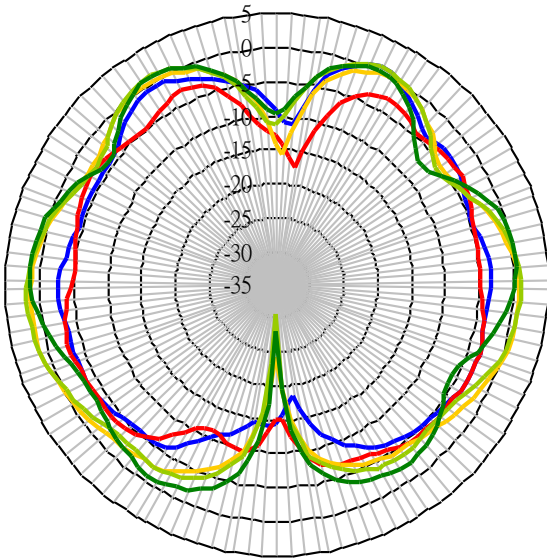

- 850MHz
- 900MHz
- 1800MHz
- 1900MHz
- 2170MHz

TG.09 90° mounted at the side of PCB (270-90)

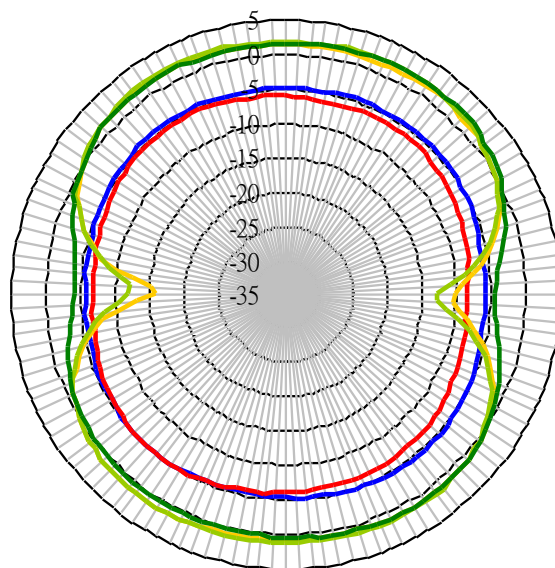
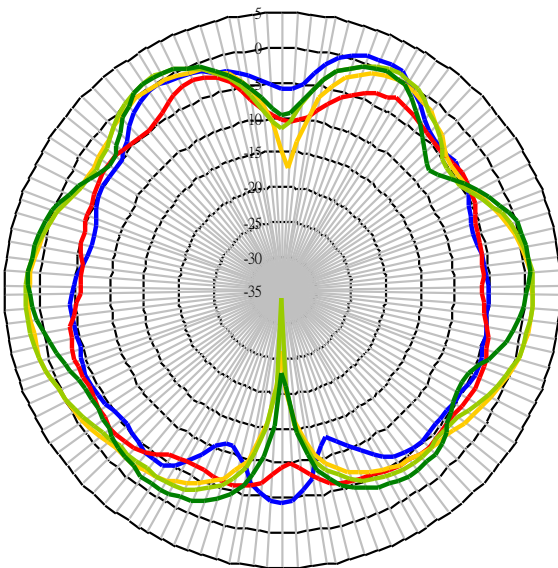

- 850MHz
- 900MHz
- 1800MHz
- 1900MHz
- 2170MHz

5.4 TG.09 Mounted on a Metal Plane

Vertical

Horizontal

TG.09 180° mounted on metal plane

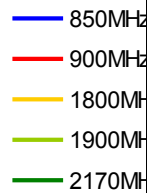
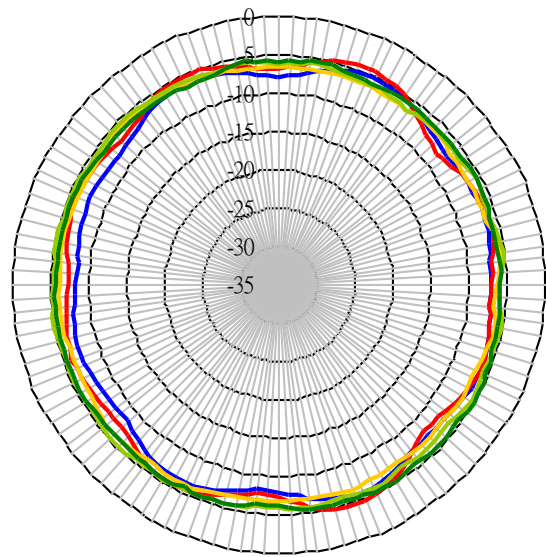
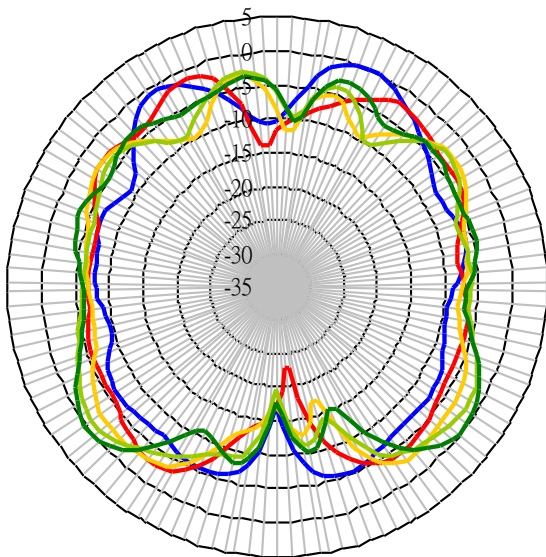

TG.09 90° mounted on metal plane (0-90)

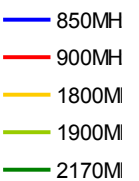
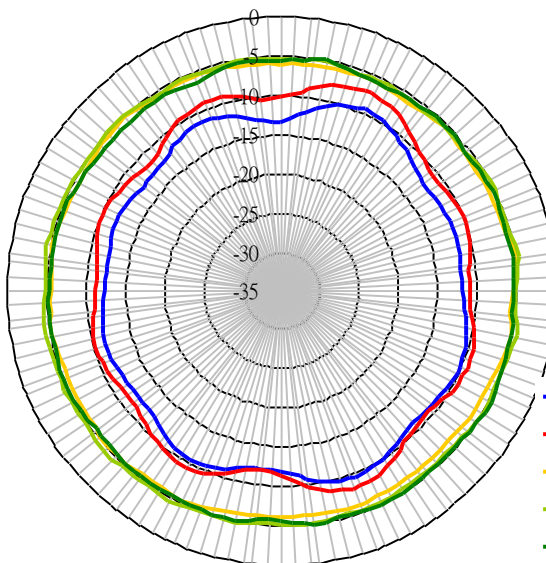
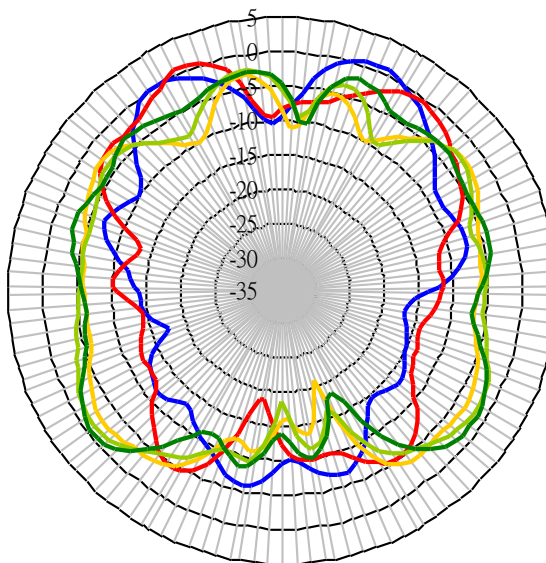

6. Mechanical Drawing (unit:mm)

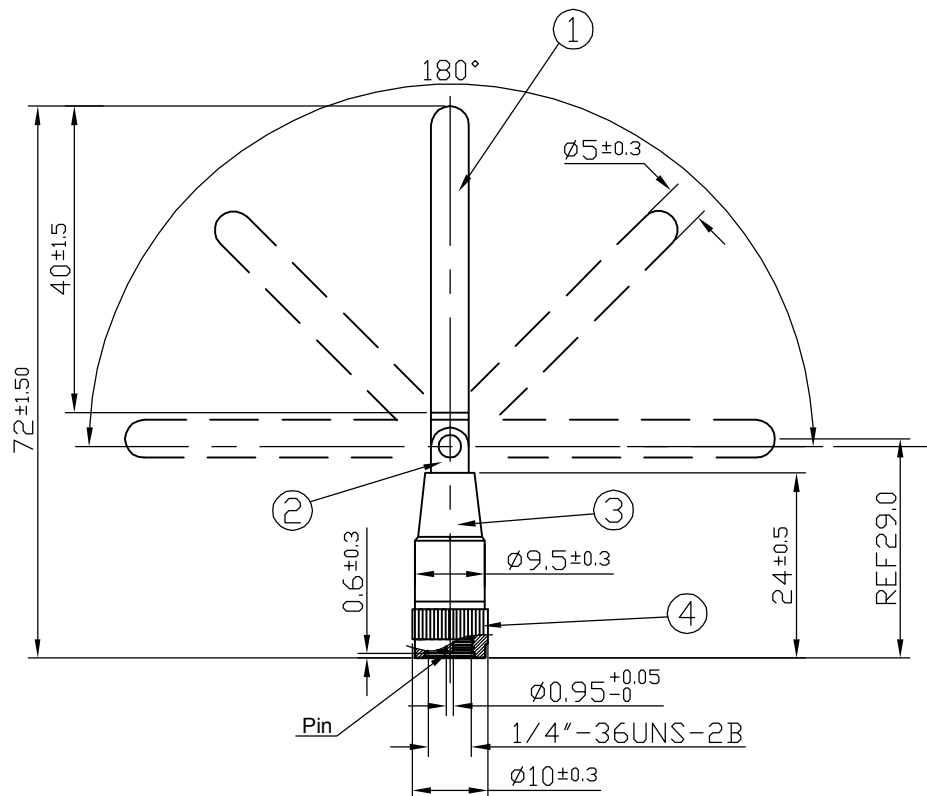
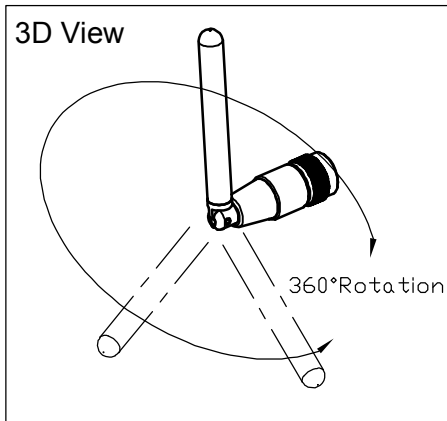

1	Housing	POM Black
2	Hinge	Brass Ni Plated
3	Cap	POM Black
4	Connector	SMA Male (Brass)

7. Packaging

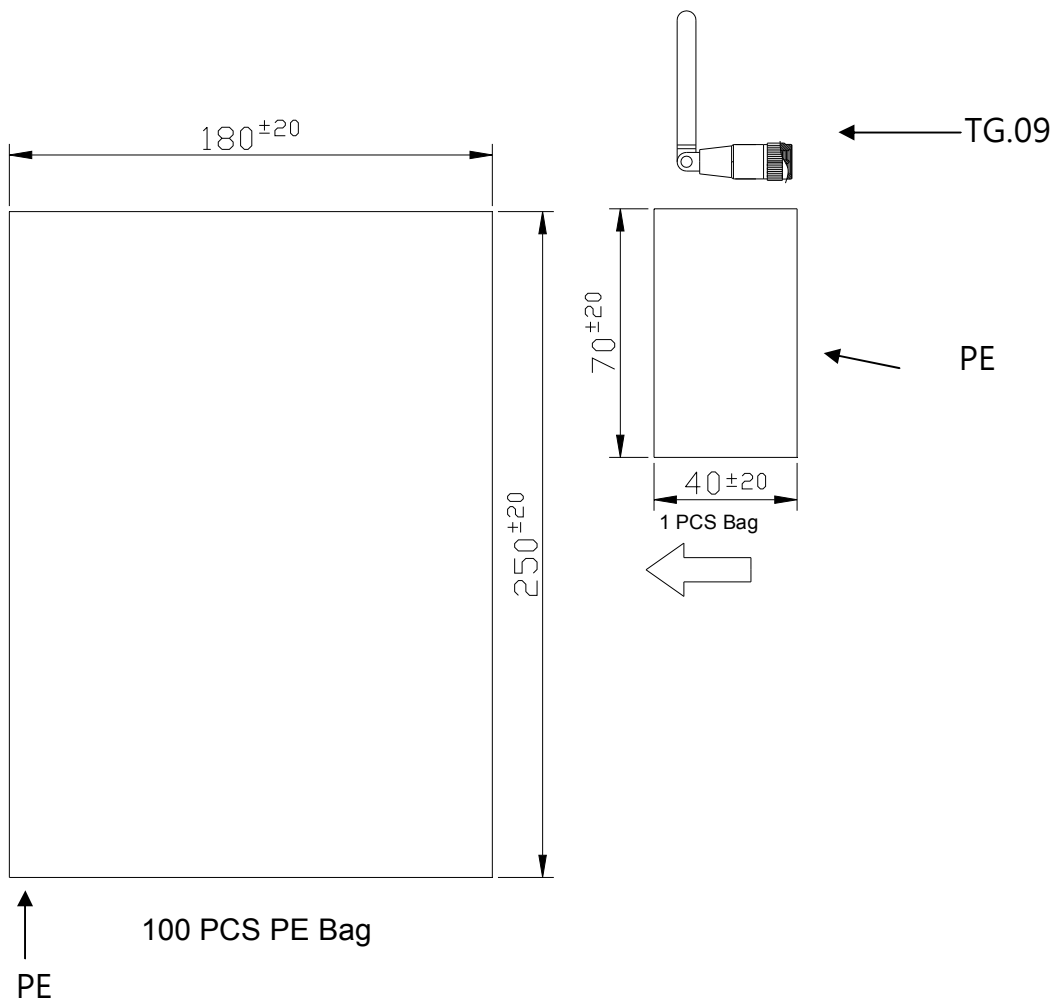

- 1pcs antennas per small PE bag.
- 100 small PE bags per big PE bag.
- 100pcs antennas per big sealed PE bag.

Taoglas makes no warranties based on the accuracy or completeness of the contents of this document and reserves the right to make changes to specifications and

product descriptions at any time without notice. Taoglas reserves all rights to this document and the information

contained herein. Reproduction, use or disclosure to third parties without express permission is strictly prohibited. Copyright © Taoglas Ltd.