

Digital batch controller



- Compact version for DN06 to DN65
- Dosing
- On site calibration by Teach-In
- Check of input/output signals
- Total and daily totalizers for batch quantity and number of batches, volume or mass totalizers displayed

Type 8035 can be combined with...



Type S030
INLINE fitting



Type 6213
Solenoid valve



Type 2301 (8692/8693)
TopControl System

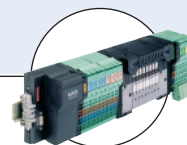

Type 8644
Valve islands

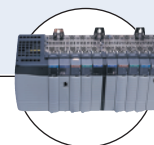

PLC

The batch controller is specially designed for use in neutral, slightly aggressive, solid-free liquids. The batch controller is made up of a compact fitting with paddle-wheel (S030) and an electronic module (SE35) quickly and easily connected together by a Quarter-Turn.

The Bürkert designed fitting system ensures simple installation of the sensors into all pipes from DN06 to DN65.

Technical data															
General data															
Compatibility	with fittings S030 (see corresponding data sheet)														
Materials	<table border="0"> <tr> <td>Housing, cover, lid, nut</td> <td>PC</td> </tr> <tr> <td>Front panel foil / Screws</td> <td>Polyester / Stainless steel</td> </tr> <tr> <td>Cable glands</td> <td>PA</td> </tr> <tr> <td>Wetted parts materials</td> <td></td> </tr> <tr> <td> Fitting, sensor armature</td> <td>Brass, stainless steel 1.4404/316L, PVC, PP or PVDF</td> </tr> <tr> <td> Paddle-wheel</td> <td>PVDF</td> </tr> <tr> <td> Axis and bearing / Seal</td> <td>Ceramics / FKM (EPDM included, but not mounted)</td> </tr> </table>	Housing, cover, lid, nut	PC	Front panel foil / Screws	Polyester / Stainless steel	Cable glands	PA	Wetted parts materials		Fitting, sensor armature	Brass, stainless steel 1.4404/316L, PVC, PP or PVDF	Paddle-wheel	PVDF	Axis and bearing / Seal	Ceramics / FKM (EPDM included, but not mounted)
Housing, cover, lid, nut	PC														
Front panel foil / Screws	Polyester / Stainless steel														
Cable glands	PA														
Wetted parts materials															
Fitting, sensor armature	Brass, stainless steel 1.4404/316L, PVC, PP or PVDF														
Paddle-wheel	PVDF														
Axis and bearing / Seal	Ceramics / FKM (EPDM included, but not mounted)														
Display	15 x 60 mm, 8-digit LCD, alphanumeric, 15 segments, 9 mm high														
Electrical connections	Cable glands M20 x 1.5														
Recommended cable	max. 50 m, shielded, 1.5 mm ² max. cross-section														
Device data (Fitting S030 + Electronics)															
Pipe diameter	DN06...DN65														
Measuring range	0.3...10 m/s (Hall transducer version)														
Fluid temperature with fitting in															
PVC / PP	0...+50°C (32...+122°F) / 0...+80°C (32...+176°F)														
PVDF, brass or stainless steel	-15...+100°C (5...+212°F)														
Fluid pressure max.	PN10 (145.1 PSI) (with plastic fitting) - PN16 (232.16 PSI) (with metal fitting) - (PN40 on request, see S030 data sheet) - see Pressure/Temperature diagram on page 2														
Viscosity / Pollution	300 cSt. max. / 1% max (size: max. 0.5 mm)														
Measurement deviation															
Teach-In	±1% of Reading ¹⁾ (at the teach flow rate value)														
Standard K-factor	±2.5% of Reading ¹⁾														
Linearity	±0.5% of F.S.* ¹⁾														
Repeatability	±0.4% of Reading ¹⁾														

* F.S.=Full scale (10 m/s)

¹⁾ Under reference conditions i.e. measuring fluid=water, ambient and water temperature=20°C (68°F), applying the minimum inlet and outlet pipe straights, matched inside pipe dimensions.

Electrical data	
Power supply (V+)	12...36 V DC (max tolerance: -5% or +10% at 12 V DC; ±10% at 36 V DC), filtered and regulated, SELV (safety extra low voltage), circuit with a non dangerous energy level or 115/230 V AC 50/60 Hz (see technical specifications 115/230 V AC)
Reversed polarity of DC	protected
Current consumption with sensor (without consumption of digital input and pulse output)	with relays ≤ 90 mA at 12 V DC; ≤ 45 mA at 36 V DC
Inputs DI (1 to 4)	Switching threshold Von: 5...36 V DC; Switching threshold Voff max: 2 V DC; Input impedance: 9.4 KOhms; Galvanic insulation, protected against polarity reversals and voltage spike
Outputs Transistors (DO1 and DO4)	NPN or PNP (wiring dependent), potential free; function: pulse output (by default for DO1), batch state (by default for DO4), configurable and parameterizable 0.6...2200 Hz, 5...36 V DC, 100 mA max., line drop 2.7 V DC at 100 mA duty cycle: ■ > 0.45 if 0.6 < frequency < 300 Hz ■ > 0.4 if 300 < frequency < 1500 Hz ■ < 0.4 if 1500 < frequency < 2200 Hz Galvanic insulation, protected against over-voltage, polarity reversals and short-circuits
Relays (DO2 and DO3)	2 relays (normally open), parameterizable (by default: DO2 always configured to control the valve, parameterized of 100% of the batch quantity and DO3 configured as alarm), 230 V AC/3 A or 40 V DC/3 A (resistive load), max. cutting power of 750 VA (resistive load)
Technical specifications 115/230 V AC	
Voltage supply available inside the device	27 V DC regulated max. current: 125 mA integrated protection: fuse 125 mA temporised power: 3 VA

Environment	
Ambient temperature (operation and storage)	-10...+60°C (14...+140°F) (version 12...36 V DC) -10...+50°C (14...+122°F) (version 115/230 V AC)
Height above sea level	max. 2000 m
Relative humidity	≤ 80 %, without condensation
Standards, directives and approvals	
Protection class (according to EN60529)	IP65 with with cable gland mounted and tightened or with obturator locked if not used.
Standard and directives	EMC Security Pressure (Fitting S030, DN06 to DN65, in PVC, PP, PVDF, stainless steel or brass) Vibration Shock
	EN 61000-6-2, EN 61000-6-3 EN 61010-1 Complying with article 3 of chap. 3 from 97/23/CE directive.* EN 60068-2-6 EN 60068-2-27
Approvals	CE; UL-Recognized for US and Canada (61010-1 + CAN/CSA-C22.2 No.61010-1) 

Specific technical data of UL-recognized products for US and Canada	
Relay output	30 V AC and 42 V peak max./3 A or 60 V DC max./1 A
Ambient temperature	-10...+60°C (14...+140°F)
Relative humidity	max. 80 %, without condensation
Intended for an inner pollution	Pollution degree 2, according to EN61010-1
Installation category	Category I, according to UL61010-1

* For the 97/23/CE pressure directive, the device can only be used under following conditions (depend on max. pressure, pipe diameter and fluid).

Type of fluid	Conditions
Fluid group 1, chap. 1.3.a	DN 25 only
Fluid group 2, chap. 1.3.a	DN ≤ 32, or DN > 32 and PN*DN ≤ 1000
Fluid group 1, chap. 1.3.b	PN*DN ≤ 2000
Fluid group 2, chap. 1.3.b	DN ≤ 200

Pressure/Temperature diagram

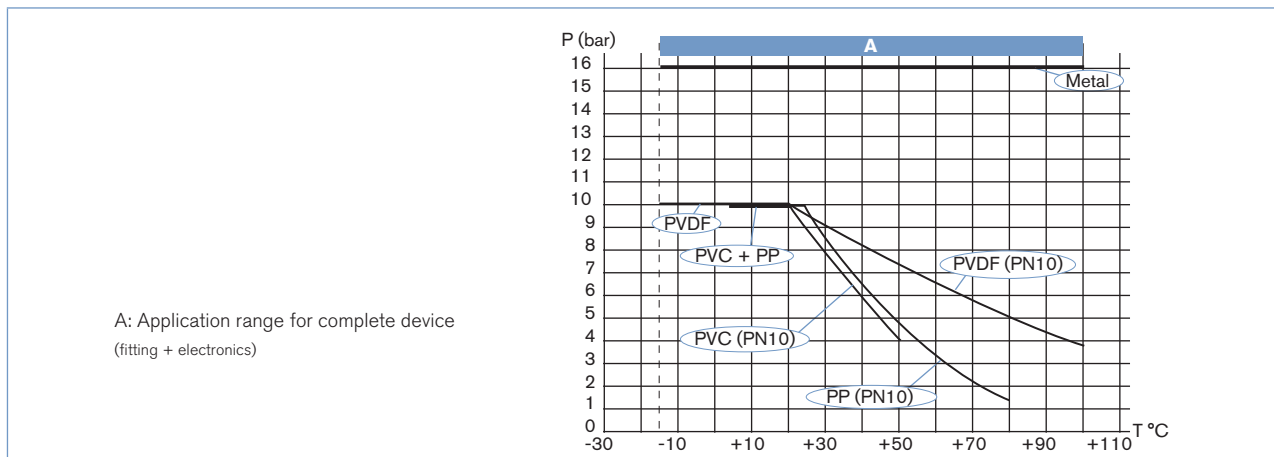

Design and principle of operation



The electronic housing (SE35) of the 8035 integrates the electronic board with display, setting parameter keys and also a transducer (Hall). The paddle-wheel is mounted in the fitting. The output signals are provided via two cable glands. Bürkert designed fitting (S030) ensures simple installation of the Bürkert controller into pipes from DN06 to DN65.

When liquid flows through the pipe, the 4 magnets, inserted in the paddle-wheel set in rotation, produce a measuring signal in the transducer. The frequency modulated induced voltage is proportional to the flow velocity of the fluid. A conversion coefficient (K factor, available in the S030 instruction manual of the fitting), specific to each pipe (size and material) enables the conversion of this frequency into a volume or a mass. The electronic component converts the measured signal and displays the actual into a volume or a mass.

Operation and display

When mounted in a pipe in series with one or two valves, the 8035 batch controller makes it possible to carry out a dosing of one or several quantities of liquids. The unit controls the opening of the valves and measures the quantity of the fluid which flows. The unit also closes the valves when the pre-set quantity has been delivered.

The electronic component needs a voltage supply of 12...36 V DC or 115/230 V AC.

The device is equipped with 4 digital inputs (DI1 up to DI4), 2 transistor outputs (DO1 configured as a pulse output and DO4 configured as state output, by default), 2 relay outputs (DO2 always configured to control the valve and by default parameterize of 100% of the batch quantity and DO3 configured as alarm output by default), two volume or mass totalizers and two batch totalizers.

The second relay output can be used to activate another valve, to initiate alarms or to generate warnings.

The following dosing modes are possible:

- **Locally started dosing of free quantity:**
the user enters the quantity to be filled and starts the dosing from the keypad.
- **Locally started dosing of preset quantity:**
the user selects a quantity which has been preset and starts the dosing from the keypad.
- **Locally started dosing of free/preset quantity**
the user enters the quantity to be filled or selects a quantity which has been preset and starts the dosing from the keypad.
- **Dosing controlled by a PLC unit**
the user selects a quantity which has been preset and starts the dosing using binary inputs.
- **Locally/remote selection of preset quantity and dosing controlled by a PLC unit:**
the user selects a quantity which has been preset from the keypad or using binary inputs and starts the dosing using binary inputs.
- **Automatic dosing controlled by variation of pulse duration:**
the quantity of the dosing is directly proportional to the duration of a pulse.
- **Remote dosing determined by Teach-In:**
Teach-In of the dosing quantity using binary inputs.
- **Local dosing determined by Teach-In:**
Teach-In of the dosing quantity from the keypads.

The device is calibrated by means of the K-factor which is either entered or determined via the Teach-In functions.

User adjustments, such as measuring range, engineering units, pulse output, etc. are carried out via the device operators interface.

The operation is specified according to five levels:

Indication in operating mode/ display	Parameter definition	Test	Information	History
<ul style="list-style-type: none"> ▪ dosing amount ▪ dosing mode ▪ main quantity totalizer ▪ daily quantity totalizer with reset function ▪ main batch totalizer ▪ daily batch totalizer with reset function 	<ul style="list-style-type: none"> ▪ language ▪ engineering units ▪ K-factor/Teach-In function ▪ selection of dosing mode ▪ over run correction ▪ alarm ▪ outputs configuration ▪ reset both quantity/batch totalizers (main and daily) ▪ Brightness of the display (backlight) 	<ul style="list-style-type: none"> ▪ input test ▪ output test ▪ frequency test ▪ warning and fault messages generating ▪ configuration mode 	<ul style="list-style-type: none"> ▪ Display of error, alarm and/or warning messages 	<ul style="list-style-type: none"> ▪ Display of the 10 latest batches

Description of the navigation keys and the status LEDs

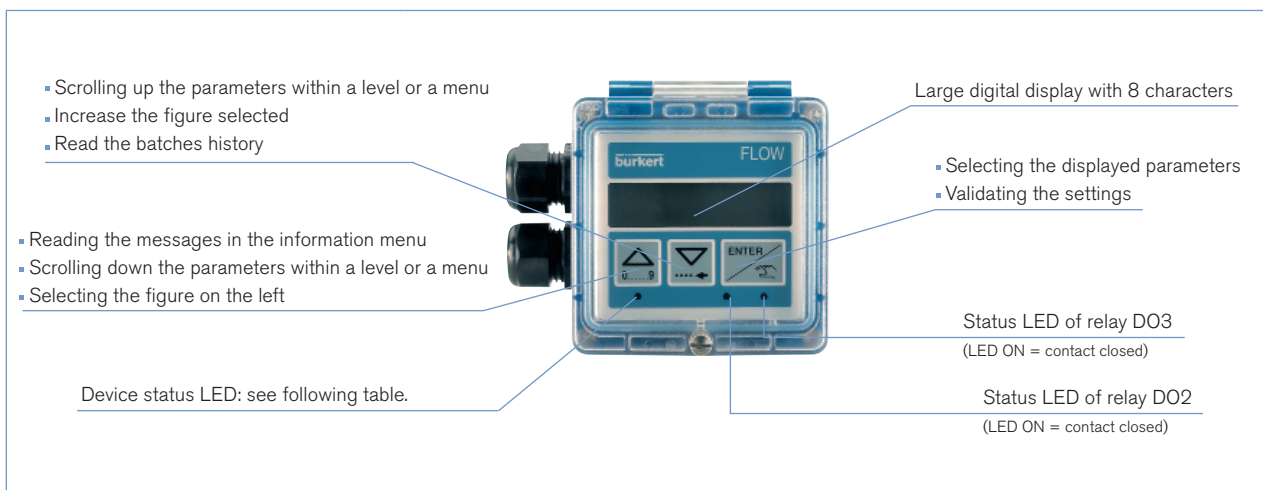

Device status LED	Status of the device
Green	The device operates correctly.
Orange	A dosing related alarm and/or a warning messages is generated in the information menu.
Red	A fault message is generated in the information menu.
Blinking, whatever the colour	<ul style="list-style-type: none"> Slow blinking: The dosing is interrupted. Fast blinking: - during a dosing: a dosing related alarm is generated. - dosing not active: the information menu has been remote-consulted or a check for the correct behaviour of the inputs/outputs is running.

Installation

The SE35 electronic can easily be installed into any Bürkert INLINE fitting system (S030) by means of a Quarter-Turn. Minimum straight upstream and downstream distances must be observed. According to the pipe's design, necessary distances can be bigger or use a flow conditioner to obtain the best accuracy. For more information, please refer to EN ISO 5167-1.

EN ISO 5167-1 prescribes the straight inlet and outlet distances that must be complied with when installing fittings in pipe lines in order to achieve calm flow conditions. The most important layouts that could lead to turbulence in the flow are shown below, together with the associated prescribed minimum inlet and outlet distances. These ensure calm, problem-free measurement conditions at the measurement point.

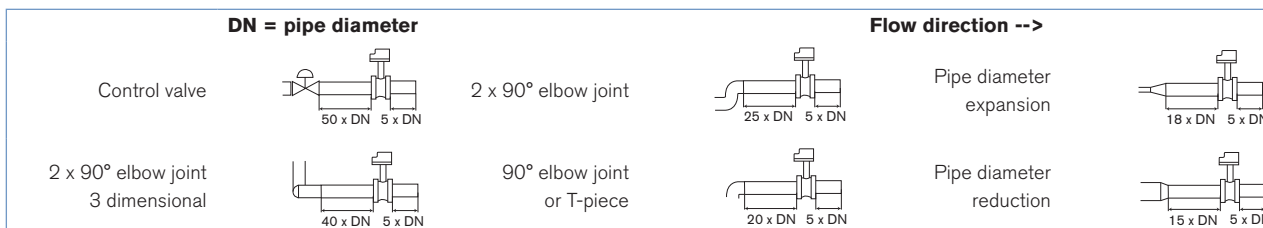

The device can be installed into either horizontal or vertical pipes. Mount the 8035 in these correct ways to obtain an accurate flow measurement.

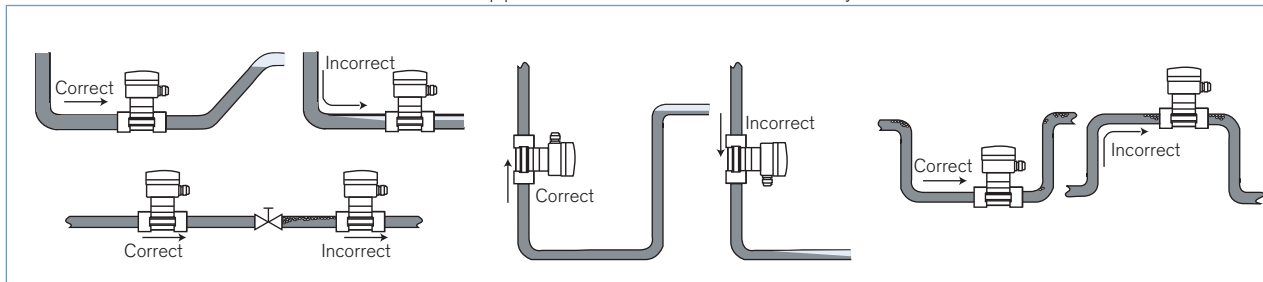

Pressure and temperature ratings must be in accordance to the selected fitting material. The suitable pipe size is selected using the diagram Flow/Velocity/DN. The batch controller is not designed for gas or steam

Diagram Flow/Velocity/DN

Dimensions [mm]

Example:

- Flow: 10 m³/h
- Ideal flow velocity: 2... 3 m/s

For these specifications, the diagram indicates a pipe size of DN40 [or DN50 for (*) mentioned fittings]

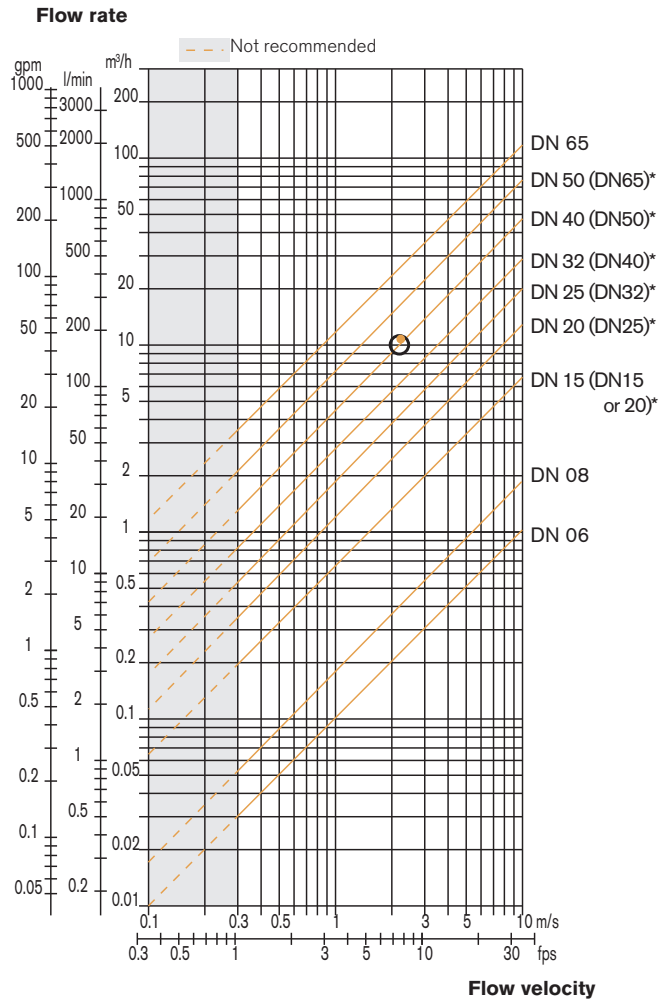

- * for following fittings with:**
- external thread acc. to SMS 1145
 - weld end acc. to SMS 3008, BS 4825-1/ASME BPE/DIN 11866 series C or DIN 11850 series 2/DIN 11866 series A/DIN EN 10357 series A
 - Clamp acc. to SMS 3017, BS 4825-3/ASME BPE or DIN 32676 series A

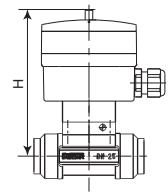
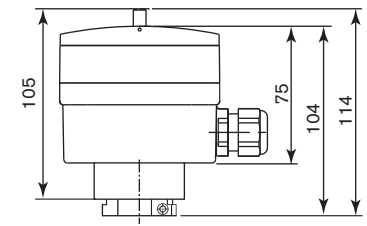
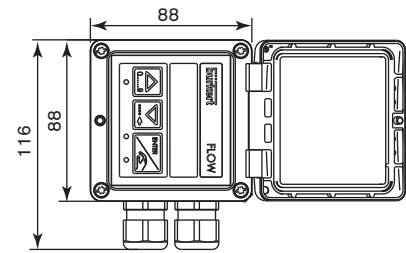
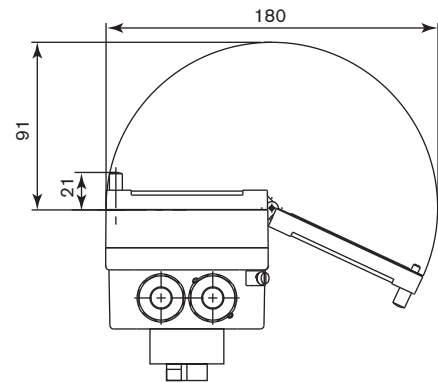

DN	H
06	134
08	134
15	139
20	137
25	137
32	140
40	144
50	151
65	151

Ordering chart for batch controller Type 8035

Batch controller with integrated paddle-wheel sensor

A batch controller Type 8035 consists of:

- an INLINE electronics Type SE35
- an INLINE fitting Type S030 (DN06 - DN65) (Refer to corresponding data sheet - has to be ordered separately)

- All these versions have as minimum:
- 2 transistor outputs (DO1 and DO4)
 - 2 relay outputs (DO2 and DO3)
 - 4 digital inputs (DI1... DI4)
 - 2 volume or mass totalizers
 - 2 batch totalizers

Specifications	Voltage supply	Sensor version	Electrical connection	Item no.
Batch controller, compact version	12...36 V DC	Hall	2 cable glands	443 360
Batch controller, compact version, UL-Recognized for US and Canada	12...36 V DC	Hall	2 cable glands	564 398
Batch controller, compact version	115/230 V AC	Hall, short	2 cable glands	423 926

NOTE: For remote version, please refer to data sheet Type 8025 Batch controller

Ordering chart - accessories for batch controller Type 8035 (has to be ordered separately)

Specifications	Item no.
Set with 2 cable glands M20 x 1.5 + 2 neoprene flat seals for cable gland or plug + 2 screw-plugs M20 x 1.5 + 2 multiway seals 2 x 6 mm	449 755
Set with 2 reductions M20 x 1.5 /NPT1/2" + 2 neoprene flat seals for cable gland or plug + 2 screw-plugs M20 x 1.5	551 782
Set with 1 stopper for unused cable gland M20 x 1.5 + 1 multiway seal 2 x 6 mm for cable gland + 1 black EPDM seal for the sensor + 1 mounting instruction sheet	551 775
Set with 8 FLOW foils	553 191

Interconnection possibilities with other Bürkert products

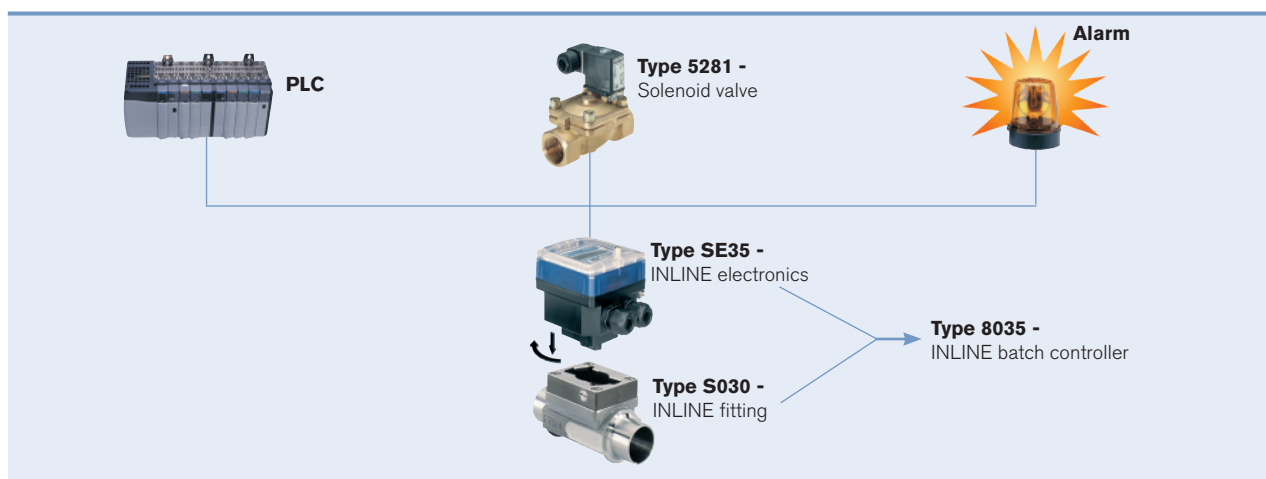

To find your nearest Bürkert office, click on the orange box →

www.burkert.com

In case of special application conditions, please consult for advice.

Subject to alteration.
© Christian Bürkert GmbH & Co. KG

1507/13_EU-en_00891787

DTS 1000011090 EN Version: P Status: RL (released | freigegeben | validé) printed: 22.09.2017