

## Type 2106

3/2 way globe valve

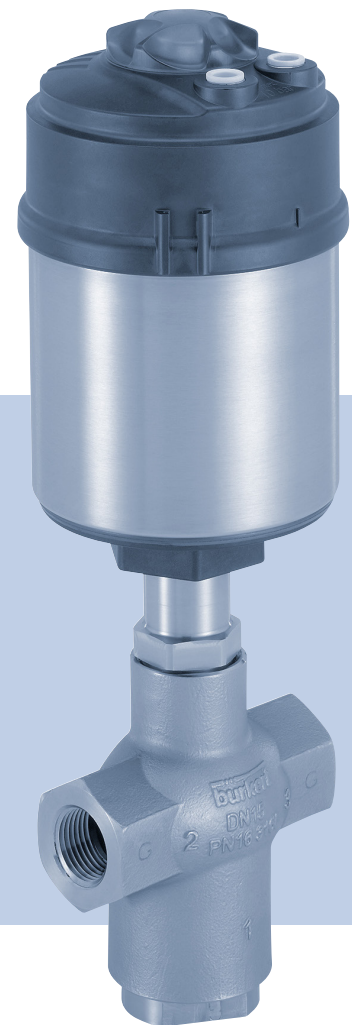

# Operating Instructions

We reserve the right to make technical changes without notice.

© Bürkert Werke GmbH & Co. KG, 2016 - 2017

Operating Instructions 1710/02\_EU-EN\_00810466 / Original DE

1	OPERATING INSTRUCTIONS .....	4
1.1	Symbols.....	4
1.2	Definitions of terms.....	4
2	AUTHORIZED USE.....	5
3	BASIC SAFETY INSTRUCTIONS .....	6
4	GENERAL INFORMATION.....	8
4.1	Contact addresses .....	8
4.2	Warranty .....	8
4.3	Information on the Internet.....	8
4.4	Conformity .....	8
4.5	Standards.....	8
5	PRODUCT DESCRIPTION.....	9
5.1	Application area.....	9
5.2	Properties.....	9
5.3	Control function and flow operating principles.....	10
6	TECHNICAL DATA .....	12
6.1	Type label .....	12
6.2	General technical data.....	12
6.3	Operating conditions .....	13
7	INSTALLATION.....	16
7.1	Preparatory work .....	16
7.2	Install the valve body.....	16
7.3	Install the control unit.....	16
7.4	Rotating the actuator.....	17
7.5	Pneumatic connection.....	18
8	DISASSEMBLY .....	19
9	ELECTRICAL CONTROL .....	19
10	MAINTENANCE, CLEANING.....	20
10.1	Maintenance .....	20
10.2	Cleaning .....	20
11	MALFUNCTIONS.....	21
12	TRANSPORT, STORAGE, PACKAGING.....	22

# 1 OPERATING INSTRUCTIONS

The operating instructions describe the entire life cycle of the device. Keep these instructions in a location which is easily accessible to every user and make these instructions available to every new owner of the device.



## **WARNING!**

**The operating instructions contain important safety information!**

Failure to observe these instructions may result in hazardous situations.

- ▶ The operating instructions must be read and understood.

## 1.1 Symbols



### **DANGER!**

Warns of an immediate danger.

- ▶ Failure to observe the warning will result in fatal or serious injuries.



### **WARNING!**

Warns of a potentially dangerous situation.

- ▶ Failure to observe the warning may result in serious injuries or death.



### **CAUTION!**

Warns of a possible danger.

- ▶ Failure to observe this warning may result in a moderate or minor injury.

### **NOTE!**

Warns of damage to property.

- ▶ Failure to observe the warning may result in damage to the device or other equipment.



indicates important additional information, tips and recommendations.



refers to information in these operating instructions or in other documentation.

- ▶ designates instructions for risk prevention.
- designates a procedure which you must carry out.

## 1.2 Definitions of terms

The term "device" used in these instructions applies to the type 2106 3/2 way globe valve described in these instructions.

In these instructions, the abbreviation "Ex" stands for "explosion-proof".

## 2 AUTHORIZED USE

Non-authorized use of the globe valve Type 2106 may be a hazard to people, nearby equipment and the environment.

- ▶ The device is designed for the controlled flow of liquid and gaseous media.
- ▶ In the potentially explosion-risk area the globe valve type 2106 may be used only according to the specification on the separate Ex type label. For use observe the additional information enclosed with the device together with safety instructions for the explosion-risk area.
- ▶ Devices without a separate Ex type label may not be used in a potentially explosive area.
- ▶ The admissible data, the operating conditions and conditions of use specified in the contract documents, operating instructions and on the type label are to be observed during use. These are described in the chapter entitled "[6. Technical Data](#)".
- ▶ Protect device from damaging environmental influences (e.g. radiation, humidity, steam, etc.). If anything is unclear, consult the relevant sales office.
- ▶ The device may be used only in conjunction with third-party devices and components recommended and authorized by Bürkert.
- ▶ Correct transportation, correct storage and installation and careful use and maintenance are essential for reliable and faultless operation.
- ▶ The exhaust air may be contaminated with lubricants in the actuator.

### 3 BASIC SAFETY INSTRUCTIONS

These safety instructions do not consider any contingencies or incidents which occur during installation, operation and maintenance. The operator is responsible for observing the location-specific safety regulations, also with reference to the personnel (e.g. by means of a warning label on the device regarding the use of hot media).



#### **DANGER!**

**Risk of injury from high pressure in the equipment or device!**

- ▶ Before working on equipment or device, switch off the pressure and deaerate or drain lines.

**Risk of injury from electric shock (when electrical component installed).**

- ▶ Before reaching into the device, switch off the power supply and secure to prevent reactivation!
- ▶ Observe applicable accident prevention and safety regulations for electrical equipment!



#### **WARNING!**

**Risk of injury when opening the actuator!**

The actuator contains a tensioned spring. If the actuator is opened, there is a risk of injury from the spring jumping out!

- ▶ The actuator must not be opened.

**Risk of injury from moving parts in the device!**

- ▶ Do not reach into openings.

**Danger due to loud noises.**

- ▶ Depending on the operating conditions, the device may generate loud noises. More detailed information on the likelihood of loud noises is available from the relevant sales office.
- ▶ Wear hearing protection when in the vicinity of the device.



#### **CAUTION!**

**Risk of burns!**

The surface of the device may become hot during long-term operation.

- ▶ Do not touch the device with bare hands.

**Leaking medium when the packing gland is worn.**

- ▶ Regularly check relief bore for leaking medium.
- ▶ If the media is hazardous, protect the area surrounding the discharge point against dangers.

**General hazardous situations.**

**To prevent injury, ensure:**

- ▶ That the system cannot be activated unintentionally.
- ▶ Installation and repair work may be carried out by authorized technicians only and with the appropriate tools.
- ▶ After an interruption in the power supply or pneumatic supply, ensure that the process is restarted in a defined or controlled manner.
- ▶ The device may be operated only when in perfect condition and in consideration of the operating instructions.
- ▶ Observe the safety regulations specific to the plant for application planning and operation of the device. Der Anlagenbetreiber ist für den sicheren Betrieb und Umgang mit der Anlage verantwortlich.
- ▶ The general rules of technology apply to application planning and operation of the device.

**To prevent damage to property of the device, ensure:**

- ▶ Supply the media connections only with those media which are specified as flow media in the chapter entitled "[6 Technical Data](#)".
- ▶ Do not put any loads on the valve (e.g. by placing objects on it or standing on it).
- ▶ Do not make any external modifications to the valves. Do not paint the body parts or screws.
- ▶ Do not transport, install or remove heavy devices without the aid of a second person and using suitable auxiliary equipment.

## **4 GENERAL INFORMATION**

### **4.1 Contact addresses**

#### **Germany**

Bürkert Fluid Control System  
Sales Center  
Christian-Bürkert-Str. 13-17  
D-74653 Ingelfingen  
Phone + 49 (0) 7940 - 10 91 111  
Fax + 49 (0) 7940 - 10 91 448  
Email: info@burkert.com

#### **International**

Contact addresses can be found on the final pages of the printed operating instructions.  
And also on the Internet at: [www.burkert.com](http://www.burkert.com)

### **4.2 Warranty**

The warranty is only valid if the device is used as intended in accordance with the specified application conditions.

### **4.3 Information on the Internet**

The operating instructions and data sheets for Type 2106 can be found on the Internet at: [www.burkert.com](http://www.burkert.com)

### **4.4 Conformity**

The device conforms to the EU directives according to the EU Declaration of Conformity (if applicable).

### **4.5 Standards**

The applied standards, which verify conformity with the EU Directives, can be found on the EU-Type Examination Certificate and / or the EU Declaration of Conformity (if applicable).



## 5 PRODUCT DESCRIPTION

The type 2106 globe valve consists of a pneumatically actuated piston actuator and a 3/2-way valve body. It uses neutral gases or air to control the flow-rate of gaseous media such as water, alcohol, oil, fuel, saline solution, lye, organic solvent or steam.

Depending on the version, the seat of the valve is closed with or against the medium flow.

Spring force (control function A) generates the closing force against the closing body. The force is transferred via a spindle which is connected to the actuator piston.

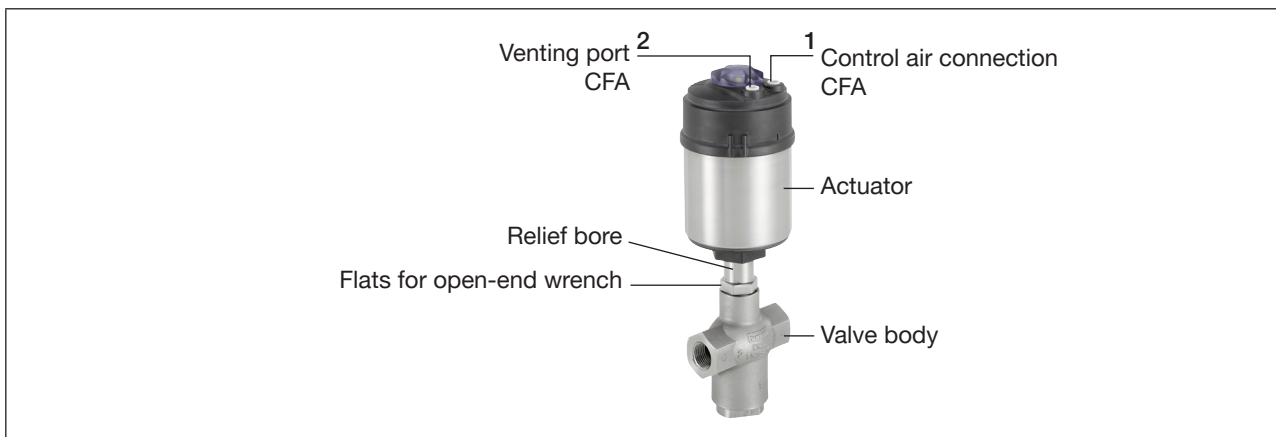

Fig. 1: 3/2 way globe valve type 2106

### 5.1 Application area



Adhere to the temperature and pressure values specified on the type label.

The device is designed for use

- Neutral gases and liquids up to 16 bar
- Steam up to 11 bar absolute / 185 °C
- Aggressive media.
- Plant construction
- Food processing
- Chemical process engineering
- Sterilizer construction

### 5.2 Properties

Key features of this valve design are:

- Continuous 360° rotation of the drive relative to valve body
- High leak-tightness by self-adjusting packing gland.
- Visual position indicator
- High seat tightness through closing body
- Maintenance-free under normal conditions of use

### 5.3 Control function and flow operating principles

**!** Different flow operating principles can be obtained with the same control function by swapping the pressure and working connections.

#### Control function A (CFA)

In rest position line connector 1 closed by spring force.

#### Flow operating principles

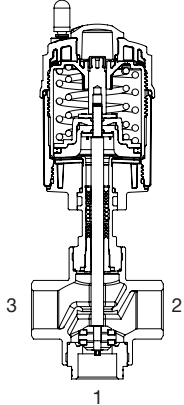
	Flow operating principle	Connection		
		1	2	3
	C	P	A	R
	D	R	A	P
	E	P1	A	P2
F	A	P	B	
<p>A, B: Working connections  P, P1, P2: Pressure inlets  R: Pressure relief</p>				

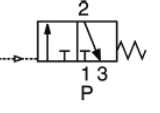
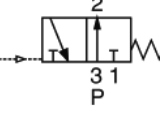
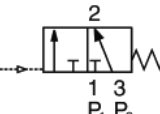
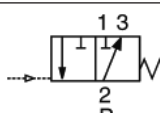
C		In rest position pressure connection 1 closed, working connection 2 relieved.
D		In the rest position, pressure inlet 3 is connected to working connection 2, relief 1 closed.
E		Mixing valve In rest position, pressure inlet 3 connected to working connection 2, pressure inlet 1 closed.
F		Distribution valve In rest position pressure inlet 2 connected to working connection 3, working connection 1 closed.

Tab. 1: Flow operating principles

#### 5.3.1 Incoming flow underneath seat (flow direction 1→2)

The bottom valve seat is closed by spring force against the media flow.  
As the medium pressure is under the closing body, this pressure contributes to opening of the valve.

### 5.3.2 Incoming flow over upper seat (flow direction 3→2)



#### **WARNING!**

Bursting of lines and device due to water hammer.

Due to the risk of water hammer, **valves with incoming flow over seat must not be used for liquid media.**

► Consider the type of incoming flow and the type of medium for operation of the device.

The bottom valve seat is closed by spring force with the media flow. As the medium pressure is over the closing body, it supports the closing process of the valve and also contributes to sealing of the valve seat. The valve is opened by the control pressure.



To ensure complete opening, the minimum control pressure must be used!

## 6 TECHNICAL DATA

### 6.1 Type label



**WARNING!**

Risk of injury from high pressure and hot media.

Excessively high pressure or high temperatures can damage the device and cause leaks.

► Adhere to the pressure and media temperature values specified on the type label.

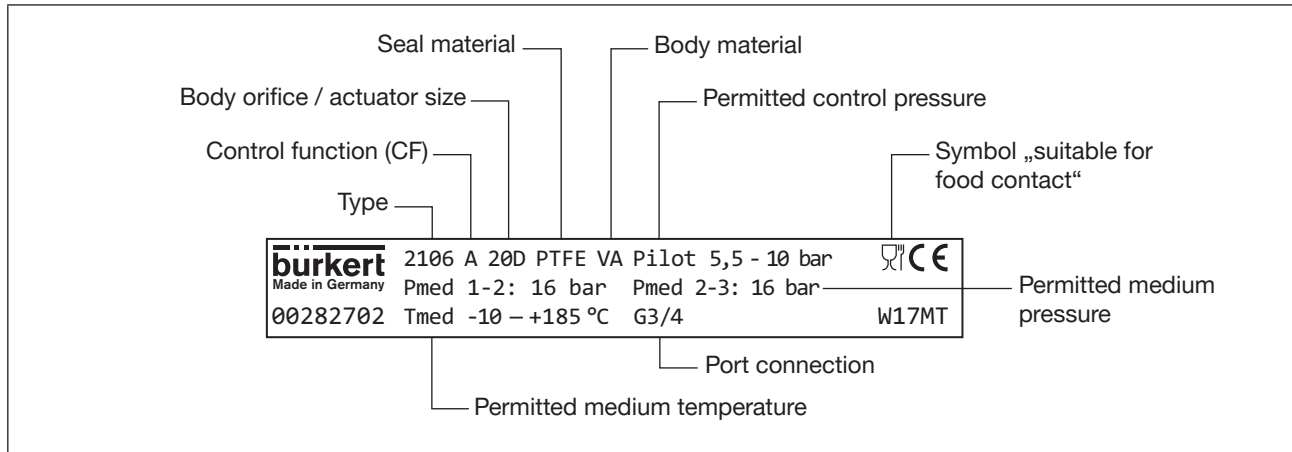

Fig. 2: Sample type label for type 2106 globe valve

### 6.2 General technical data

Actuator size See type label

Control function See type label

#### Media

Control medium Neutral gases, air

Flow media Water, alcohol, fuels, hydraulic fluids, saline solutions, lyes, organic solvents

#### Materials

Valve body Stainless steel 316L

Actuator PPS and stainless steel

Sealing elements FKM and EPDM

Spindle sealing (with silicone grease) PTFE V-rings with spring compensation

Closing body seat seal PTFE

Spindle 1.4401 / 1.4404

Spindle guide PEEK

#### Connections

Control air connection Plug-in hose connector 6/4 mm or resp. 1/4", others on request

Port connection Fitting G1/2...G2 (NPT, RC on request)

Protection class IP67 in accordance with IEC 529/EN 60529

## 6.3 Operating conditions

### 6.3.1 Temperature ranges

Actuator size	Actuator material	Medium (with PTFE seal)	Ambient temperature <sup>1)</sup>	
			Pilot air ports as plug-in hose connectors	Pilot air ports as threaded bushings
ø 50 mm (D)	PPS	-10...+185 °C	-10...+60 °C	-10...+100 °C
ø 70 mm (M)				
ø 90 mm (N)				
ø 130 mm (P)				

Tab. 2: Temperature ranges



1) If a pilot valve is used, the max. ambient temperature is +55 °C.



The globe valve is suitable for steam sterilization.

### 6.3.2 Pressure Ranges

Control pressure (for standard spring force)

Actuator size [ø in mm]	Required minimum control pressure [bar]	Maximum control pressure [bar]
50 (D)	5.5	10
70 (M)	4.5	
90 (N)	5.1	
130 (P)	≤DN 50: 4.9	7

Tab. 3: Control pressure

Required minimum control pressure depending on medium pressure

Valve seat orifice [mm]	Actuator size [ø in mm]	Flow direction 1→2		Flow direction 2→3 Flow direction 2→1	
		Maximum medium pressure [bar]	Required minimum control pressure [bar]	Maximum medium pressure [bar]	Required minimum control pressure [bar]
15	50 (D)	16	5.5	16	6.2
15	70 (M)	16	4.5	16	4.5
20	50 (D)	16	5.5	16	6.5
20	70 (M)	16	4.5	16	4.7
25	50 (D)	9	5.5	11	6.2
25	70 (M)	16	4.5	16	5.0
32	70 (M)	8	4.5	11	6.0
32	90 (N)	11	5.1	16	6.2
40	70 (M)	7	4.5	11	6.0
40	90 (N)	12	5.1	16	6.2
50	90 (N)	9	5.1	8	6.0
50	130 (P)	16	4.9	16	6.0

Tab. 4: Minimum control pressure

Control pressure diagram (CFA, flow direction 3→2)

- D = actuator size Ø 50 mm
- M = actuator size Ø 70 mm
- N = actuator size Ø 90 mm
- P = actuator size Ø 130 mm

15M means: valve seat orifice 15 mm, actuator size Ø 70 mm

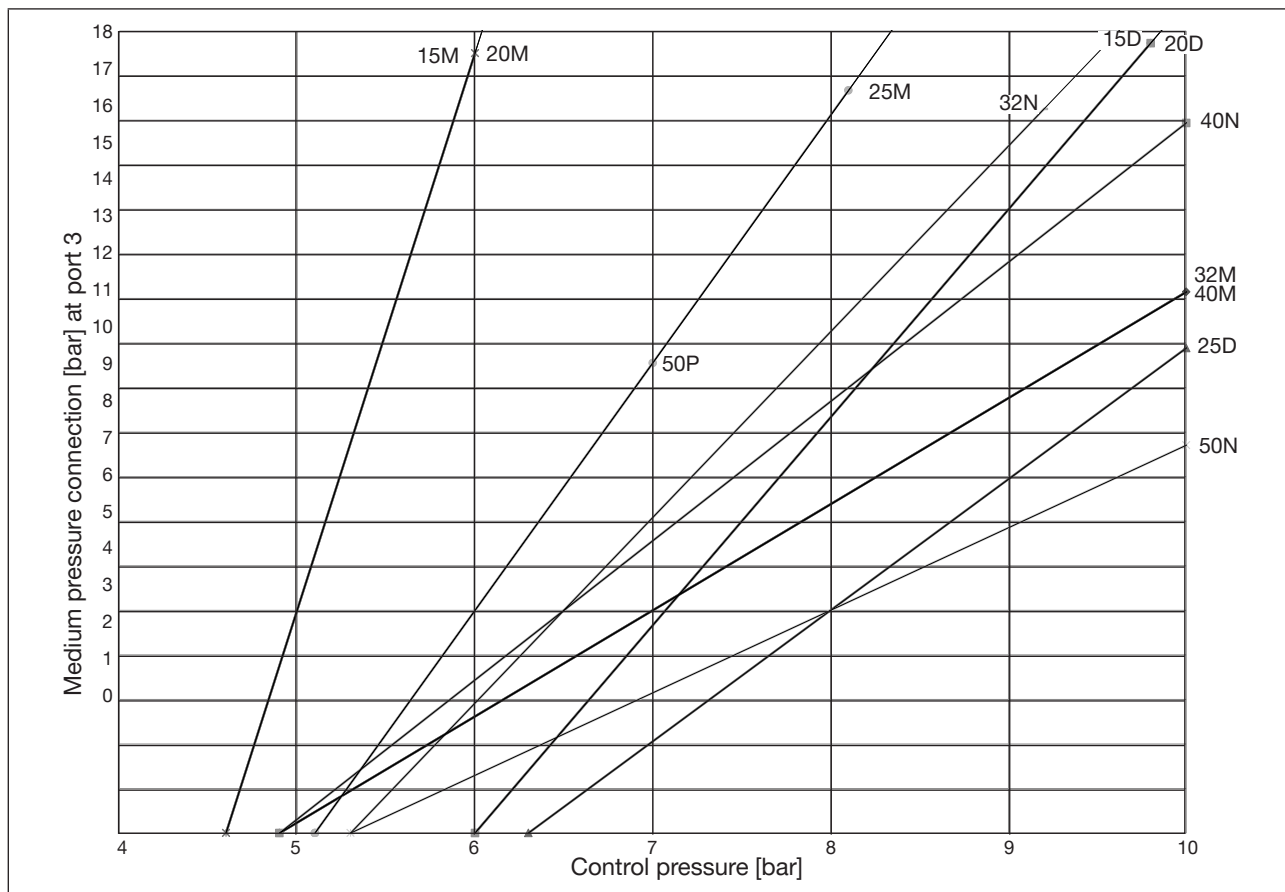

Fig. 3: Control pressure diagram

## 7 INSTALLATION



### **DANGER!**

**Risk of injury from high pressure in the system.**

- ▶ Before loosening lines and valves, turn off the pressure and vent the lines.



### **WARNING!**

**Risk of injury from improper assembly.**

- ▶ Installation may only be carried out by authorized specialist personnel and using the appropriate tools.

**Risk of injury from unintentional activation of the system and uncontrolled restart.**

- ▶ Secure system against unintentional activation.
- ▶ Following assembly, ensure a controlled restart.

**Risk of injury due to moving parts in the device.**

- ▶ Don't reach into openings.



### **CAUTION!**

**Risk of injury due heavy devices!**

- ▶ During transport or during assembly, a heavy device may fall and cause injury.
- ▶ Do not transport, install or remove heavy devices without the aid of a second person and using suitable auxiliary equipment.
- ▶ Use appropriate tools.

### 7.1 Preparatory work

- Ensure that the pipelines are aligned.
- Observe flow direction (see type label).
- Clean pipelines (sealing material, swarf, etc.).

### 7.2 Install the valve body

Any installation position is possible, preferably with actuator face up.

- Connect housing to pipeline.

### 7.3 Install the control unit



Refer to the installation capital of the corresponding control unit operating instruction for a description.



## 7.4 Rotating the actuator

The position of the connections can be aligned steplessly by rotating the actuator through 360°.



### WARNING!

Risk of injury due to discharge of medium and pressure release.

If the direction of rotation is wrong, the housing interface may become detached.

- ▶ Only turn the actuator in the specified sense of direction (see "Fig. 5").

### NOTE!

Damage to the seat seal or the seat contour!

- ▶ The valve must be in the center position when turning the actuator.

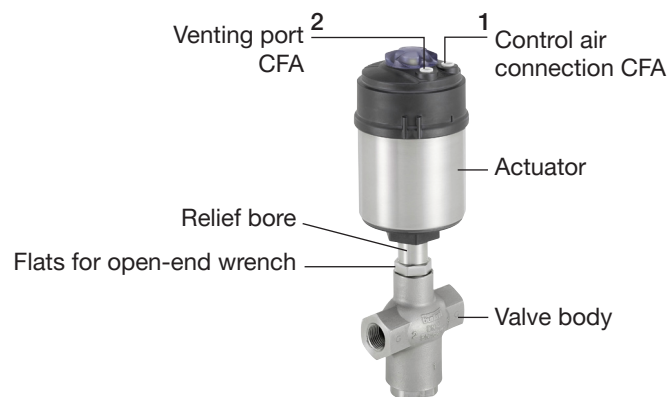

Fig. 4: 3/2 way globe valve type 2106

- Clamp the valve body into a holding device (applies only to valves not yet installed).
- Apply compressed air to control air connection 1:
  - 3.5 bar for actuator size 50 (D) and 70 (M)
  - 4.0 bar for actuator size 90 (N) and 130 (P)
- Using a suitable open-end wrench, counter the wrench flat on the fitting.
- Place a suitable open-end wrench on the hexagonal bolt of the actuator.
- Move the actuator to the required position by turning it counter-clockwise (viewed from below).

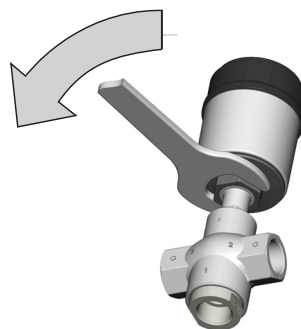

Fig. 5: Rotating the actuator

## 7.5 Pneumatic connection



### DANGER!

Risk of injury from high pressure in the system.

- ▶ Before loosening lines and valves, turn off the pressure and vent the lines.



### WARNING!

Risk of injury from unsuitable connection hoses.

Hoses which cannot withstand the pressure and temperature range may result in hazardous situations.

- ▶ Use only hoses which are authorized for the indicated pressure and temperature range.
- ▶ Observe the data sheet specifications from the hose manufacturers.



If the position of the pilot air ports for installation of the hoses is unfavorable, these can be aligned steplessly by rotating the actuator through 360°.

The procedure is described in the chapter [“7.4 Rotating the actuator”](#).

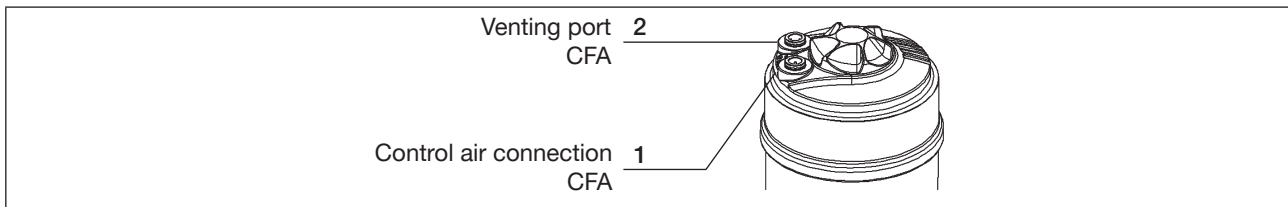

Fig. 6: Pneumatic Connection

→ Connect control medium to control air connection 1 of the actuator (see [“Fig. 6”](#)).

### Silencer

On versions with plug connection, the silencer to reduce the exhaust air noise is supplied as a separate item.

→ Plug the silencer into the free air venting port 2 (see [“Fig. 6”](#)).



If used in a corrosive environment, we recommend running a pneumatic hose from all free pneumatic connections to a neutral atmosphere.

### Control air hose:

Control air hoses of sizes 6/4 mm or 1/4" can be used.

Optionally a control air connection is possible via a G 1/8 thread.

## 8 DISASSEMBLY



### DANGER!

**Risk of injury due to discharge of medium and pressure release!**

It is dangerous to remove a device which is under pressure due to the sudden pressure release or discharge of medium.

- ▶ Before removing a device, switch off the pressure and vent the lines.

→ Loosen the pneumatic connection.

→ Remove device.

## 9 ELECTRICAL CONTROL

The type 2106 valve can be combined with the following controls:

- Type 8690 pneumatic control unit
- Type 8691 control head (actuator size  $\varnothing 70 - \varnothing 130$ )
- Type 8695 control head ( actuator size  $\varnothing 50$ )
- Type 8645 FreeLINE automation system
- Type 6012 pilot valve
- Type 6014 P pilot valve



The electrical connection of the pilot valve or the control is described in the respective operating instructions for the pilot valve/control.

## 10 MAINTENANCE, CLEANING



### DANGER!

**Risk of injury from high pressure in the system.**

- ▶ Before loosening lines and valves, turn off the pressure and vent the lines.

**Risk of injury due to electric shock.**

- ▶ Before reaching into the system, switch off the electrical power supply and secure to prevent reactivation.
- ▶ Observe applicable accident prevention and safety regulations for electrical equipment.



### WARNING!

**Risk of injury due to improper maintenance work.**

- ▶ Maintenance may be performed by authorized technicians only.
- ▶ To screw on or unscrew valve body or actuator, use an open-end wrench, never a pipe wrench, and observe tightening torques.

**Risk of injury from unintentional activation of the system and uncontrolled restart.**

- ▶ Secure system against unintentional activation.
- ▶ Following maintenance, ensure a controlled restart.

**Risk of injury due to moving parts in the device.**

- ▶ Don't reach into openings.

### 10.1 Maintenance

The device drive is maintenance-free if the information in these operating instructions is observed.

#### Visual inspection:

Perform regular visual inspections according to the conditions of use:

- Check medium connections for leak-tightness.
- Check relief bores on the pipe for leaks.



Fig. 7: Relief bore

### 10.2 Cleaning

Commercially available cleaning agents can be used to clean the outside.

#### NOTE!

**Avoiding damage caused by cleaning agents.**

- ▶ Before cleaning, check that the cleaning agents are compatible with the housing materials and seals.

## 11 MALFUNCTIONS

Malfunction	Remedial action
Actuator does not switch	Control air connection interchanged (see "7.5 Pneumatic connection") → Connect control air connection 1
	Control pressure too low → Observe the pressure rating on the type label
	Medium pressure too high → Observe the pressure rating on the type label
	Direction of flow interchanged → Observe the flow direction on the type label
Malfunction	Remedial action
Valve is not sealed	Dirt between seal and valve seat → Installing dirt trap
	Seat seal worn → Replace the valve
	Direction of flow interchanged → Observe the flow direction on the type label
	Medium pressure too high → Observe the pressure rating on the type label
	Control pressure too low → Observe the pressure rating on the type label
Valve is leaking on the relief bore	Packing gland worn → Replace the valve

Tab. 5: Malfunctions

## 12 TRANSPORT, STORAGE, PACKAGING

### NOTE!

#### Transport damage.

Inadequately protected devices may be damaged during transportation.

- ▶ Protect the device against moisture and dirt in shock-resistant packaging during transportation.
- ▶ Prevent the temperature from exceeding or dropping below the permitted storage temperature.

#### Incorrect storage may damage the device.

- ▶ Store the device in a dry and dust-free location.
- ▶ Storage temperature: -20...+65 °C.

#### Damage to the environment caused by device components contaminated with media.

- ▶ Dispose of the device and packaging in an environmentally friendly manner.
- ▶ Observe applicable disposal and environmental regulations.



Observe the national waste disposal regulations.



