

Multi-channel process and program controller



- Brilliant 5" colour graphics display, with 27 colours
- Freely configurable screen templates
- Up to 4 controller channels
- 50 programmes, with 1,000 segments under dynamic management

Type 1150 can be combined with...



Type 6013
Compact solenoid valve



Type 5282
Solenoid valve



Type ST20
Resistance thermometer/RTD



Type 8035
Flow transmitter/
Batch controller



Type 8175
Level transmitter

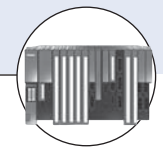

PLC
Programmable Logic Control systems

The Type 1150 is a process and program controller with up to 4 controller or program channels. The instrument is built to the format 144 mm x 130 mm for a standard 92 mm x 92 mm panel cut-out and a mounting depth of 170 mm.

The display is a 5" color graphics display (27 colours). The layout of the screen templates can be individually adapted and adjusted. Two freely configurable screen templates make it possible to customize the placing of texts, process values, background pictures and icons.

A maximum of 4 analog inputs and 6 logic inputs are available, as well as six expansion slots for switched or analog outputs.

A setup program is available for comfortable configuration from a PC.

Linearizations for the usual transducers are stored within the instrument, four customer-specific linearization tables can be programmed. A math and logic module can be used to adapt the instrument to a very wide range of control tasks.

Two serial interfaces, RS422/485 or Profibus-DP, can be used to integrate the instrument into a data network.

Modules can be retrofitted quite simply by the user (see block structure).

The electrical connection is made at the rear of the instrument, via plug-in screw terminals.

Block structure

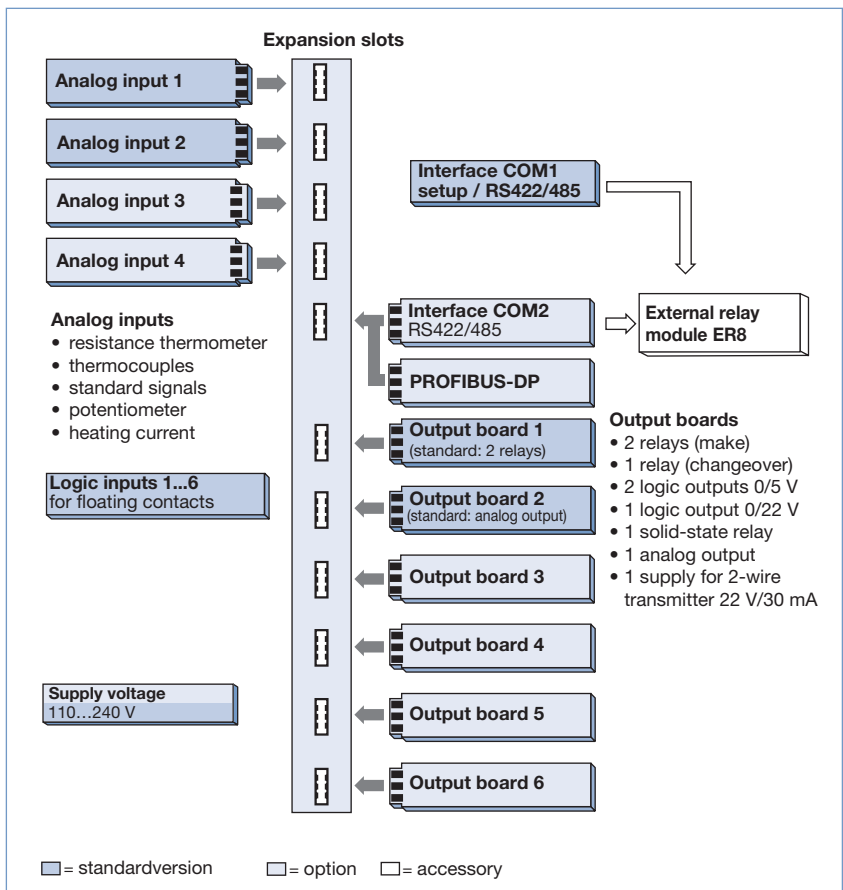

Displays and controls

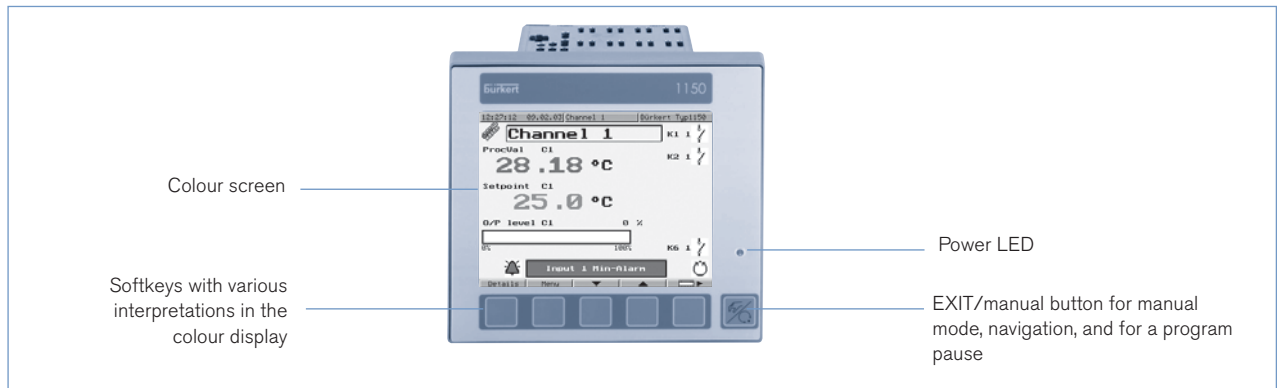

Operating concept

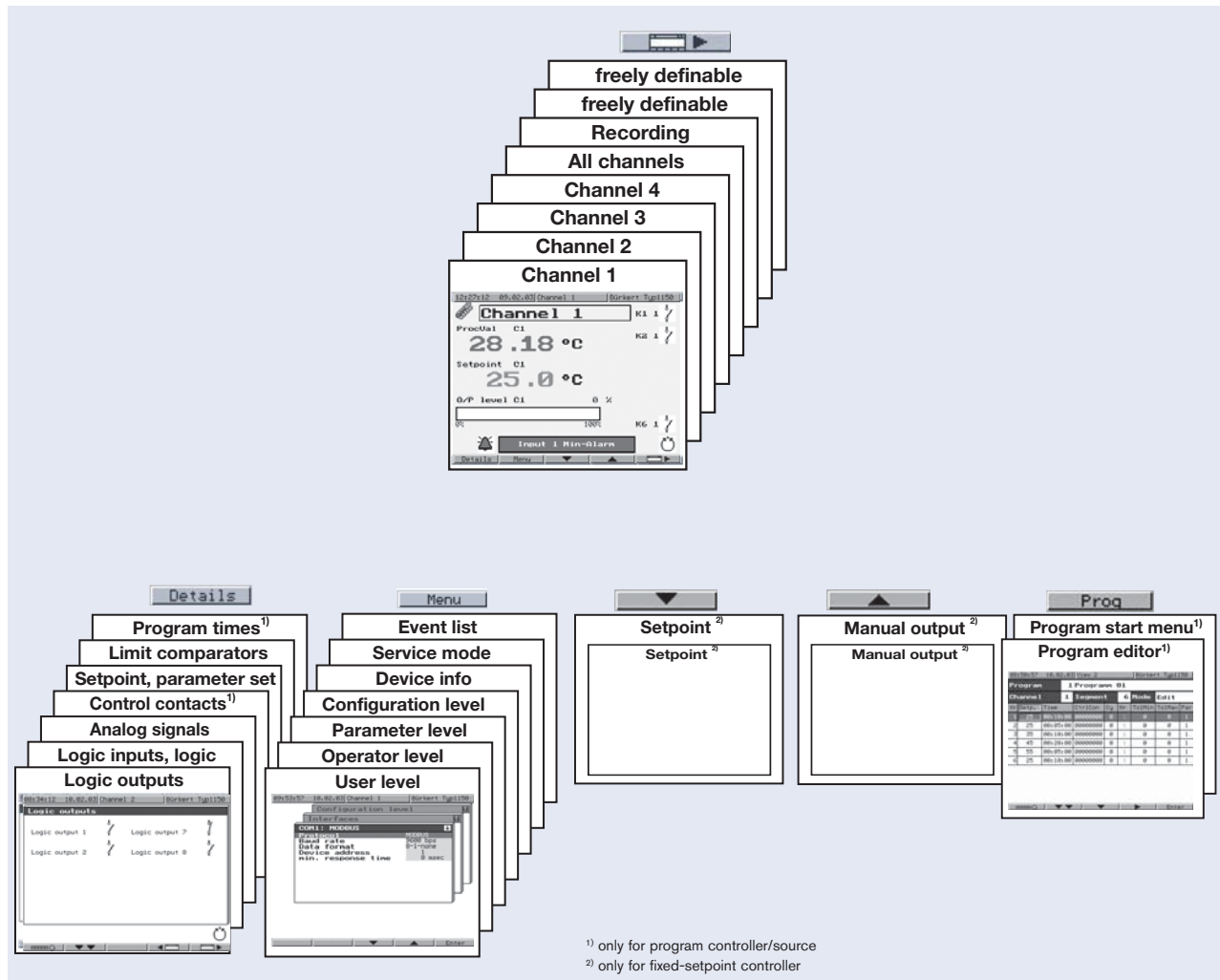

The operation, configuration and displays are organized in a structural arrangement in the screen templates. The insertion of the (variable) softkey functions in the lower section of the screen keeps the user continually informed about the operating options. The instrument is configured through the well-established level structure (operating, parameter and configuration levels). A customer-specific arrangement of those parameters that

frequently have to be altered (user level) can also be implemented by using the setup program.

A wide variety of process values and status displays (e.g. switching states of the limit comparators) are visualized clearly and in detail. Operating states and alarms are indicated by definable texts and icons in a reserved area of the screen. Unused screen templates can be switched out of the display.

Operating concept

Recording¹⁾

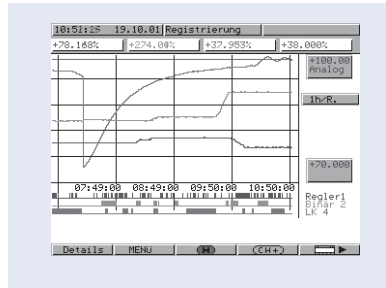

The recording function is used to create a graphical representation of the development of process values. This can be used to observe and optimize control processes.

Features:

- free choice of signals for 4 analog channels and 3 logic channels
- memory storage cycle 60–3600 measurements per hour
- ring memory for 43,200 measurements, this memory is overwritten after 24 hrs.
- readout of data via the interface

Self-optimization

Standard features include self-optimization, making it possible for the controller to be matched to the control loop by a user who is not a control-technology expert. This functions by evaluating the response of the control loop to specific changes in the manipulating variable. Either an oscillatory method or a step-test response

can be selected. The controller parameters that are calculated are: proportional band, reset time, derivative time, filter time constant, and cycle time.

Ramp function

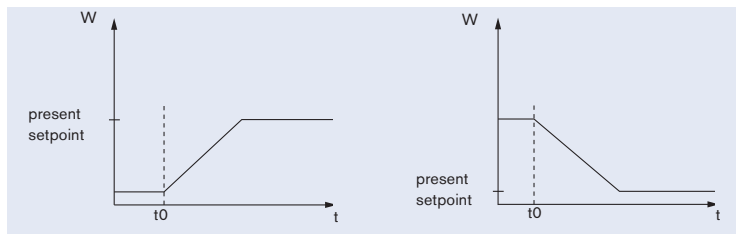

In a fixed-setpoint controller, the ramp function enables a defined run-up of the process value from t_0 until it reaches the given setpoint value.

The rate of change is defined as a gradient ($^{\circ}\text{C}/\text{min}$, $^{\circ}\text{C}/\text{hour}$ or $^{\circ}\text{C}/\text{day}$). When the setpoint changes, this function is activated in the rising or falling direction. The ramp function can be activated individually for each channel.

Customer-specific linearization

In addition to the linearizations for the usual transducers, up to four customer-specific linearizations can be created.

The programming is carried out in the setup program, in the form of a table of values or a formula.

Configurable screen templates

Two freely configurable screen templates are available for arrangement into user specific layouts. Using the accessory setup program, representations of process values and graphics are selected from a library and

assembled into the screen template in a graphics editor. Some graphical elements can also be incorporated.

Configurable texts

The accessory setup program can be used to define up to 100 texts for use as messages and representations in the screen templates. Furthermore, all instru-

ment texts can be changed or translated into other languages.

Event list

Important events, such as alarm messages, external texts or system messages, are collected together in an event list.

User level

Parameters which frequently have to be changed by the user can be collected together and displayed in the

screen template "User level" (only through the setup program).

Math and logic module¹⁾

The math module makes it possible to combine values such as setpoints, output levels and measurements into a mathematical formula. The logic module can be used to make a logical combination of such elements as logic inputs and limit comparator states. Up to 8 math or logic formulae can be entered through the setup

program, and the results of the calculations can be presented at the outputs or used for internal purposes.

Difference, ratio, and humidity control

Controllers for difference, ratio, and humidity can be achieved through standard formulae that have been included.

Cascade controller

Demanding control tasks can be handled by configuring the instrument as a cascade or trimmer cascade controller. Four controller

channels can be used to implement two cascade controllers.

C-level controller¹⁾

The instrument can be used as a C-level controller, to regulate the level of carbon in the atmosphere of a gas coking furnace.

The sensing device in this case is a zircon dioxide probe.

¹⁾ Option

Explanations/functions

Logic functions

- Start/stop of self-optimization
- Change to manual mode
- Inhibit manual mode
- Ramp stop/OFF
- Setpoint changeover
- Process value changeover
- Parameter set switching
- Key/level inhibit
- Text display
- Screen saving
- Screen switching
- Acknowledge limit comparators
- Program start/stop/cancel
- Inhibit program start
- Program selection
- Fast forwards
- Segment change

The logic functions can be combined with one another.

Functions of the outputs

- Analog input variables
- Math
- Process value
- Setpoint
- Ramp end value
- Control deviation
- Output level
- Cascade output level
- Program end value
- Residual segment time
- Segment time
- Program time
- Residual program time
- Controller outputs
- Limit comparators
- Control contacts
- Logic inputs
- Logic
- Program end
- Ramp end
- Manual mode signal

Program controller

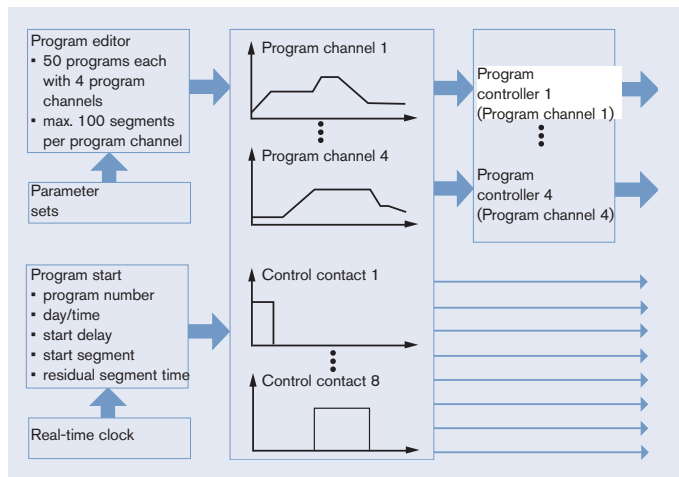

50 programs can be created, with a maximum of 4 program channels. The program channels run synchronously, and can each contain up to 100 segments. A total of 1000 segments can thus be programmed.

Furthermore, 8 control contacts can be programmed and assigned to the program channels. These are also run synchronously.

The start of a program can be initiated manually, by pressing a key on the instrument (or an external button), or through the programming of the start conditions. The start time can be determined either by defining a start delay or by programming a date and time. A weekly program can also be entered into the instrument, through the setup program.

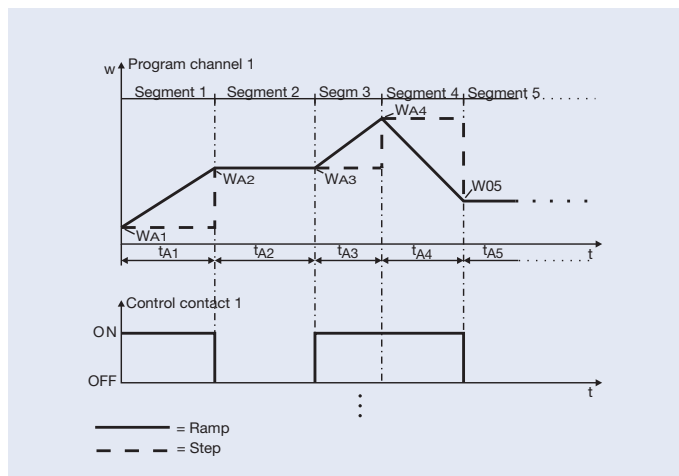

Program channels are made up from a sequence of segments containing defined segment setpoints. The individual segment setpoints can optionally be linked to ramp or step functions.

The state of the 8 control contacts can be influenced by each segment. In addition, one of two programmable parameter sets and an upper and lower limit (tolerance band) for monitoring the process value can be assigned to each segment.

Endless loops can be implemented by programming repeated cycles.

Segments are defined by the segment setpoint and the segment time.

Explanations/functions

Program editor

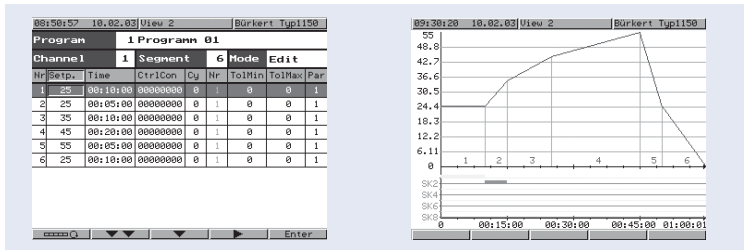

The integrated program editor can be used for the comfortable creation and alteration of programs.

The program profiles and the states of the control contacts can be graphically displayed as a function of the time.

The setup program can be used to program a second setpoint sequence per program channel.

Setup program (accessory)

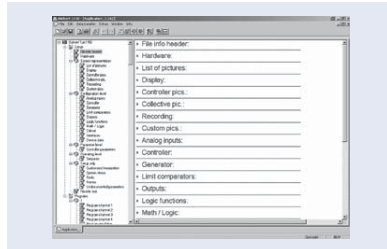

The setup program for configuring the instrument is available in German, English and French. Using a PC, you can create and edit sets of data, and transfer them to the controller or read them out from the instrument. The data sets are stored and managed.

Interfaces

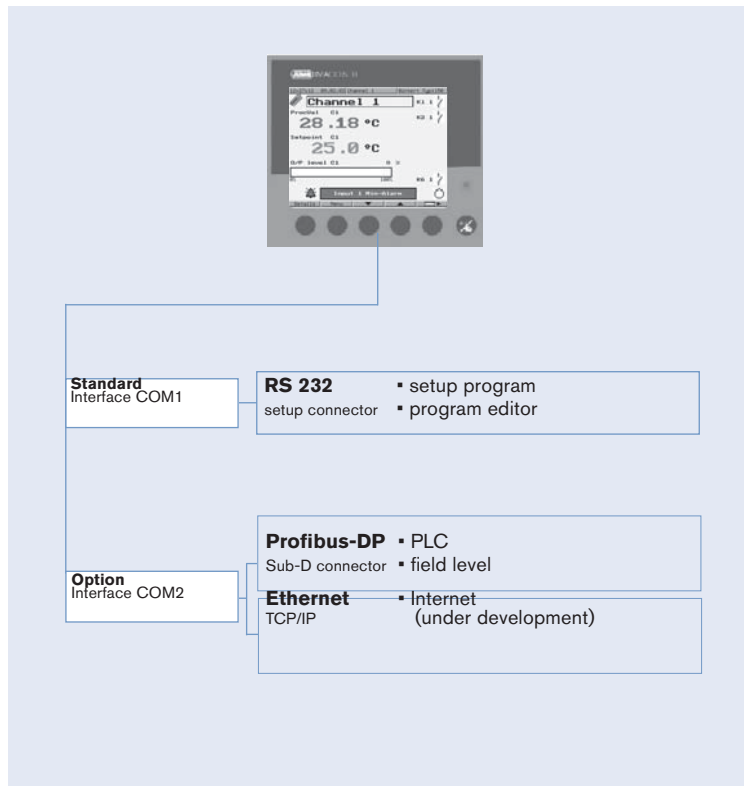

Profibus-DP¹⁾

The Profibus-DP interface can be used to integrate the controller into a fieldbus system operating according to the Profibus-DP standard. This Profibus version is especially designed for communication between automation systems and decentralized peripheral devices at the field level, and optimized for speed. The data transmission is made serially, using the RS485 standard.

GSD generator, the project-planning tool that is supplied with the package (GSD = Gerätetammdaten, i.e. basic device data), is used to make a selection of device characteristics for the controller to create a standardized GSD file that is used to integrate the controller into the fieldbus system.

¹⁾ Option

Parameter level

All the parameters and their meanings are included in the table. Some parameters may be omitted or meaningless for a particular type of controller. Two parameter sets can be stored, to handle special applications.

Parameter	Value range	Factory setting	Meaning
Controller structure	P, I, PD, PI, PID	PID	Control loop feedback
Proportional band	0 to 9999 digits	0 digits	Size of the proportional band 0 means that the controller structure is out of action!
Derivative time	0 to 9999 sec	80 sec	Determines the differential component of the controller output signal
Reset time	0 to 9999 sec	350 sec	Determines the integral component of the controller output signal
Cycle time	0 to 9999 sec	20 sec	When using a switched output, the cycle time should be chosen so that the energy flow to the process is quasi continuous, i.e. as continuous as is practicable without overloading the switching elements
Contact spacing	0 to 999 sec	0 digits	The spacing between the two controller contacts for double-setpoint or modulating controllers, or proportional controllers with an integrated actuator driver
Switching differential	0 to 999 digits	1 digits	Hysteresis for switching controllers with proportional band = 0
Actuator time	5 to 3000 sec	60 sec	The actually utilized operating time of the regulator valve with modulating controllers or proportional controllers with an integrated actuator driver
Working point	-100 to +100%	0%	The output level for P and PD controllers (if $x = w$ then $y = Y_0$)
Output level limiting	0 to 100% -100 to +100%	100% -100%	The maximum limit for the output level The minimum limit for the output level
Minimum relay ON time	0 to 60 sec	0 sec	Limits the frequency of switching for switched outputs

Electrical isolation

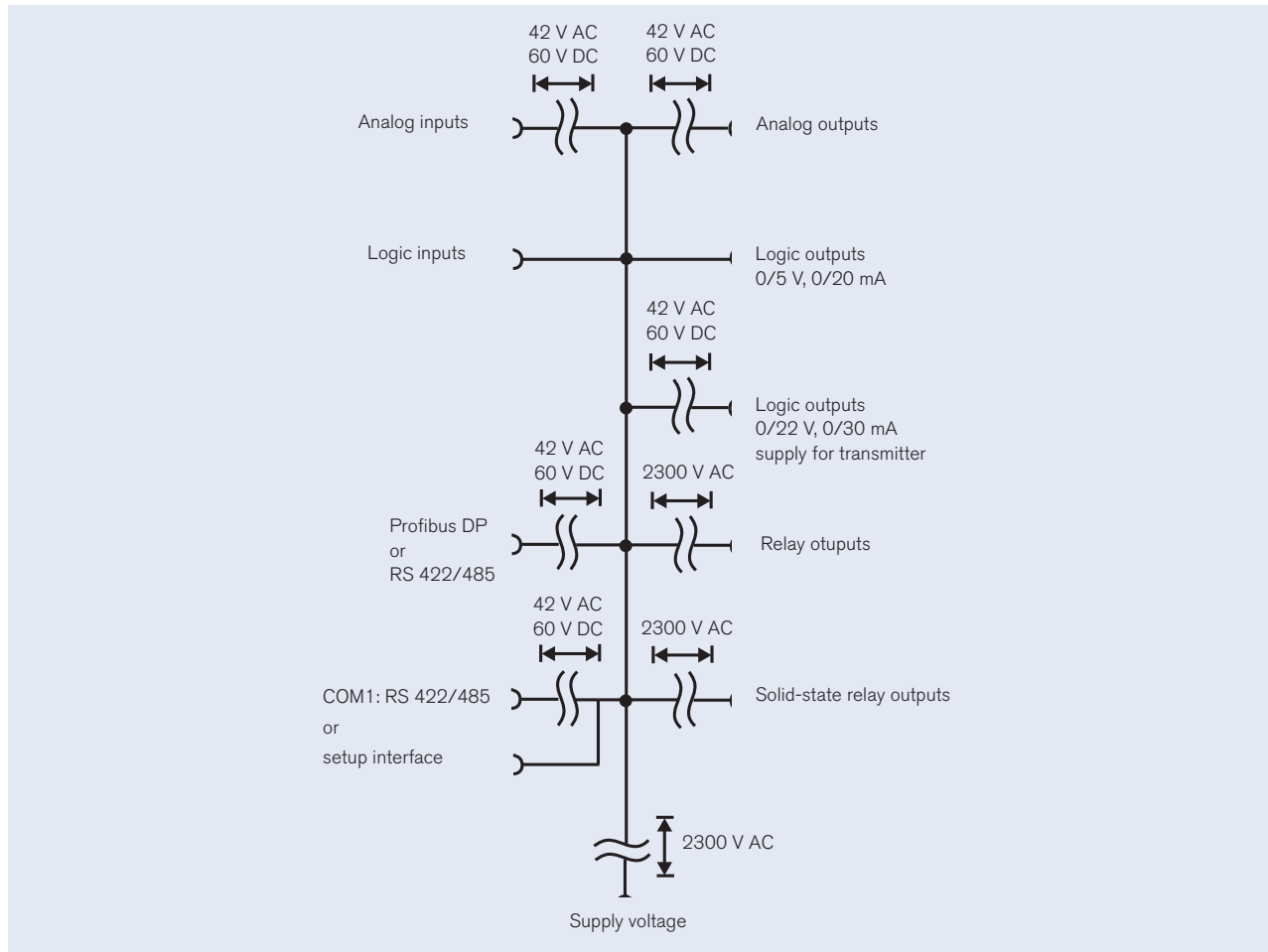

Technical data

Thermocouple input

Designation	Measurement range	Measurement accuracy ¹⁾	Ambient temperature error
Fe-Con "L"	-200 to + 900°C	≤0.25%	100 ppm/°C
Fe-Con "J" EN 60 584	-200 to +1200°C	≤0.25%	100 ppm/°C
Cu-CuNi "U"	-200 to + 600°C	≤0.25%	100 ppm/°C
Cu-Con "T" EN 60 584	-200 to + 400°C	≤0.25%	100 ppm/°C
NiCr-Ni "K" EN 60 584	-200 to +1372°C	≤0.25%	100 ppm/°C
NiCr-Con "E" EN 60 584	-200 to +1000°C	≤0.25%	100 ppm/°C
NiCrSi-NiSi "N" EN 60 584	-200 to +1300°C	≤0.25%	100 ppm/°C
Pt10Rh-Pt "S" EN 60 584	0 to 1768°C	≤0.25%	100 ppm/°C
Pt13Rh-Pt "R" EN 60 584	0 to 1768°C	≤0.25%	100 ppm/°C
Pt30Rh-Pt6Rh "B" EN 60 584	0 to 1820°C	≤0.25%	100 ppm/°C
W5Re-W26Re "C"	0 to 2320°C	≤0.25%	100 ppm/°C
W3Re-W25Re "D"	0 to 2495°C	≤0.25%	100 ppm/°C
W3Re-W26Re	0 to 2400°C	≤0.25%	100 ppm/°C
Cold junction	Pt 100 internal, external or constant		

¹⁾ With 250 msec sampling time

Input for resistance thermometer

Designation	Connection circuit	Measurement range	Measurement accuracy ¹⁾	Ambient temperature error
Standard Pt100 EN 60 751	2-wire/3-wire	-200 to +850°C	≤0.05%	50 ppm/°C
Pt 50,500,1000 EN 60 751	2-wire/3-wire	-200 to +850°C	≤0.1%	50 ppm/°C
Cu50	2-wire/3-wire	-50 to +200°C	≤0.1%	50 ppm/°C
Ni100 DIN 43 760	2-wire/3-wire	-60 to +250°C	≤0.05%	50 ppm/°C
KTY11-6	2-wire	-50 to +150°C	≤1.0%	50 ppm/°C
PtK9	2-wire	Lithium-chloride sensor		
Sensor lead resistance	max. 30Ω per lead for 2-wire or 3-wire circuit			
Meas. current	250 μA			
Lead compensation	Not required for 3-wire circuit. With a 2-wire circuit, the lead resistance can be compensated in software by a correction of the process value.			

Input for standard signals

Designation	Measurement range	Measurement accuracy ¹⁾	Ambient temperature error
Voltage	0 to 10 V	≤0.05%	100 ppm/°C
	-10 to +10 V	≤0.05%	100 ppm/°C
	-1 to +1 V	≤0.05%	100 ppm/°C
	0 to +1 V	≤0.05%	100 ppm/°C
	0 to 100 mV	≤0.05%	100 ppm/°C
	-100 to +100 mV	≤0.05%	100 ppm/°C
	Input resistance RIN > 100 kΩ		
Current	4 to 20 mA, voltage drop ≤1 V	≤0.1%	100 ppm/°C
	0 to 20 mA, voltage drop ≤1 V	≤0.1%	100 ppm/°C
Heat current	0 to 50 mA AC	≤1%	100 ppm/°C
Potentiometer	min. 100 Ω, max. 10 kΩ		

¹⁾ With 250 msec sampling time

Logic inputs

Floating contacts

Technical data

Measurement circuit monitoring

In the event of a fault, the outputs move to a defined (configurable) status.

Sensor	Overrange/underrange	Probe or lead short-circuit	Probe or lead break
Thermocouple	▪	–	▪
Resistance thermometer	▪	▪	▪
Voltage 2 to 10V 0 to 10V	▪ ▪	▪ –	▪ –
Current 4 to 20mA 0 to 20mA	▪ ▪	▪ –	▪ –

▪ = recognized – = not recognized

Outputs

Relay contact rating contact life	changeover contact, or 2 x make 3A at 250 V AC resistive load 150,000 operations at rated load		
Logic current limiting	0/5 V 20 mA	or	0/22 V 30 mA
Solid-state relay contact rating protection circuitry	1 A at 230 V varistor		
Voltage output signals load resistance	0 to 10 V / 2 to 10 V $R_{load} \geq 500 \Omega$		
Current output signals load resistance	0 to 20 mA / 4 to 20 mA $R_{load} \leq 450 \Omega$		
Supply voltage for 2-wire transmitter voltage current	22 V 30 mA		

Controller

Controller type	single-setpoint controller, standard double-setpoint controller, modulating controller, proportional controller, proportional controller with integrated actuator drive
Controller structures	P/PD/PI/PID/I
A/D converter	dynamic resolution up to 16 bit
Sampling time	250 msec standard 50 msec, 150 msec, 250 msec (configurable)

Color screen

Resolution	320 x 240 pixels
Size (screen diagonal)	5" (12.7 cm)
No. of colours	27 colours

Technical data

Electrical data

Supply voltage (switchmode PSU)	110-240 V AC -15/+10% 48-63 Hz	<i>Standard</i>
Electrical safety	to EN 61 010, Part 1 overvoltage category III, pollution degree 2	
Power consumption	max. 30 VA	
Data backup	Flash memory	
Electrical connection	at rear, via plug-in screw terminals conductor cross-section max. 2.5 mm ² with core ferrules (length: 10 mm)	
Electromagnetic compatibility interference emission interference immunity	EN 61 326 Class B to industrial requirements	

Housing

Housing type	housing and rear panel: metal for panel mounting as per ISO 43 700	
Front bezel	plastic to UL94 V0 144 mm x 130 mm	
Mounting depth	170 mm	
Panel cut-out	95 ^{+0.8} x 92 ^{+0.8} mm	
Ambient/storage temperature range	-5 to 50°C/-40 to +70°C	
Climatic conditions	rel. humidity ≤75% annual mean, no condensation	
Operating position	horizontal	
Enclosure protection	to EN 60 529 front IP 65, rear IP 20	
Weight (fully fitted)	approx. 1400 g	
Membrane keypad	polyester film, resistant to normal washing and cleaning agents	

Interface (COM1)

Interface type	PC-interface or RS 422/RS 485	
Protocol	MODbus	
Baud rate	9600, 19200, 38400	
Device address	1-255	
Minimum response time	0-500 msec	

Interface (COM2)

Profibus		
Device address	1-128	

Connection diagram

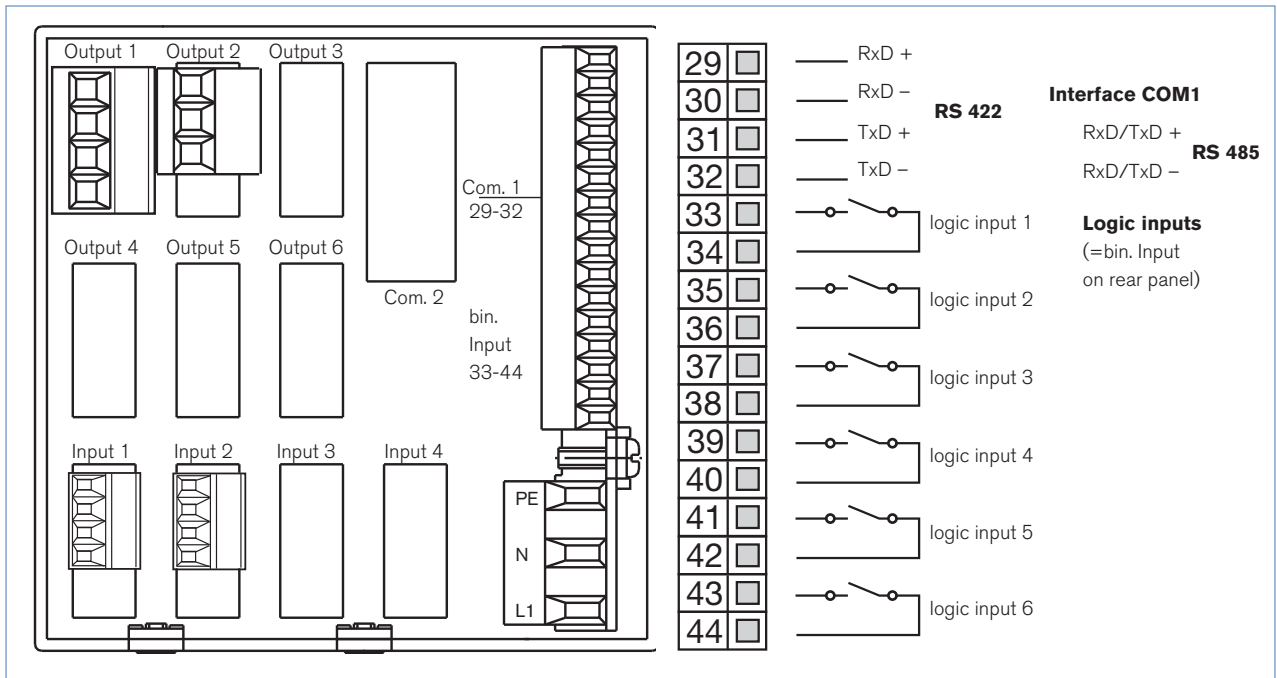

Analog inputs

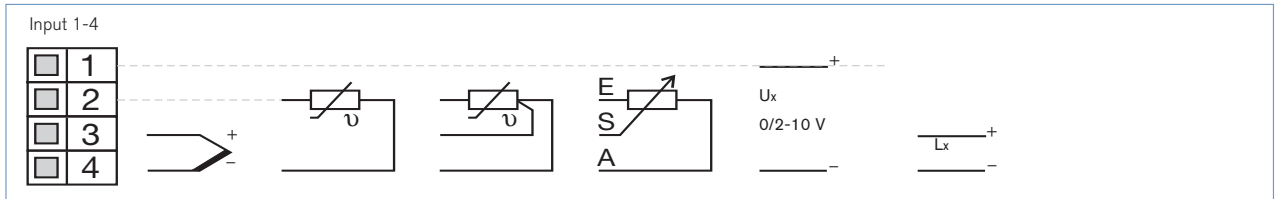

Outputs

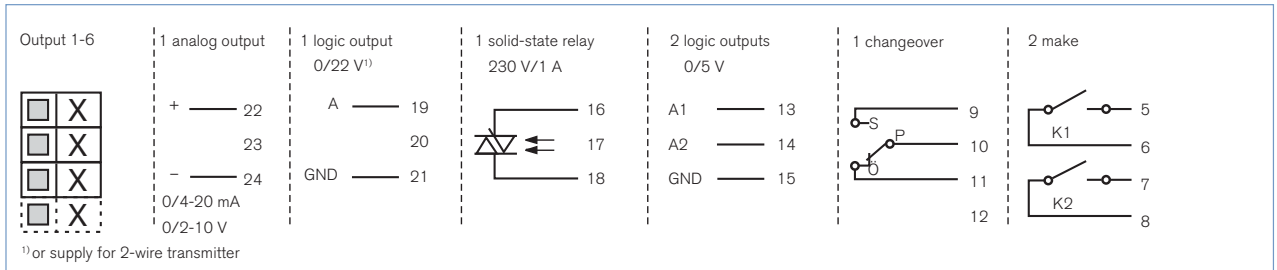

Supply voltage

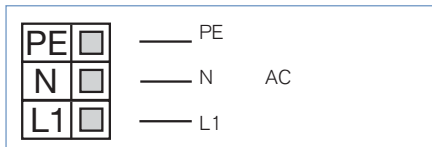

Interfaces



Dimensions [mm]

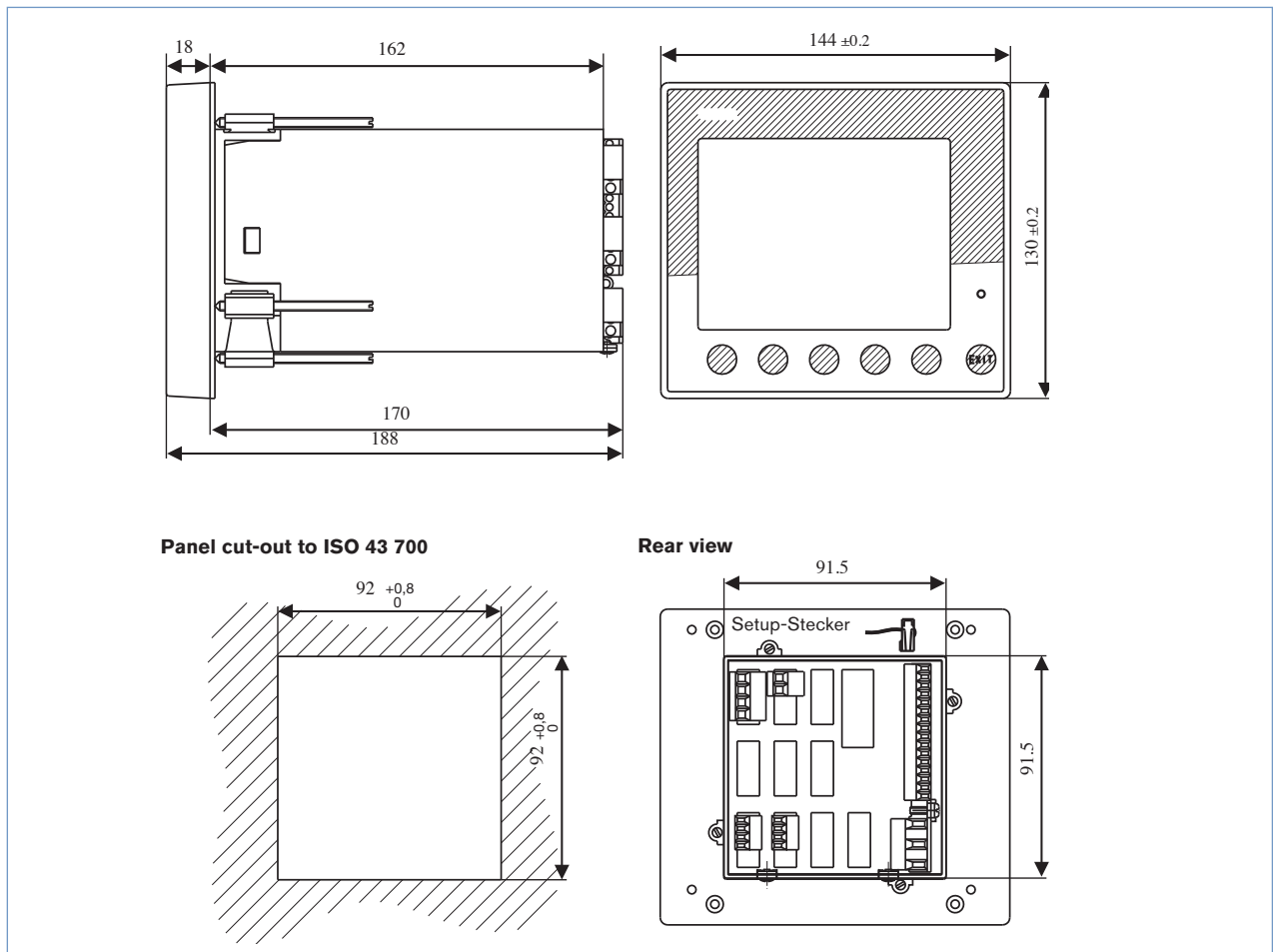

Ordering chart for Type 1150

Description	Item no.
Basic Type	
20-30 V AC/DC	787 703
110-240 V 48-63 Hz	787 704
Input Module	
1 analog input	787 750
Output module	
1 relay, changeover	787 751
1 semiconductor relay	787 752
2 relays, N/O contact	787 753
1 analog output	787 754
Interface	
Profibus DP	787 755
Supplementary units ¹⁾	
Instrument channels 3+4	787 756
Registering function	787 757
Mathematical and logic module	787 758
Accessories	
PC-Interface for setup programmes	787 759
Setup software with programme editor	787 760

¹⁾ After the delivery of the basic type can this only be activated through the setup software.

To find your nearest Bürkert facility, click on the orange box → www.burkert.com

In case of special application conditions,
please consult for advice.

Subject to alterations
© Christian Bürkert GmbH & Co. KG

0910/1_EU-en_00891892