

### Autoranging Mini Multimeter

Model MN16A

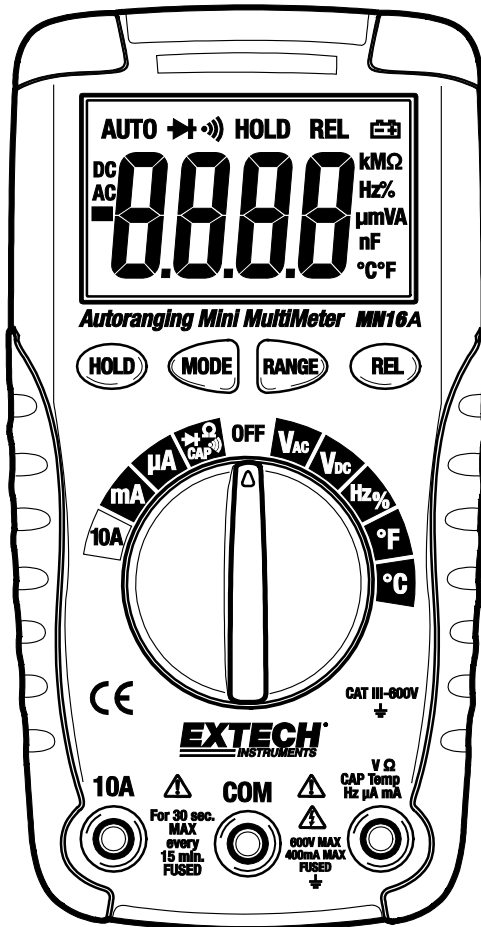

## Introduction

---

Congratulations on your purchase of the Extech MN16A Autoranging Multimeter. This meter measures AC/DC Voltage, AC/DC Current, Resistance, Capacitance, Frequency, Diode Test, and Continuity plus Thermocouple Temperature. It features a rugged design for heavy duty use. This meter is shipped fully tested and calibrated and, with proper use, will provide years of reliable service.

## Safety

---



This symbol adjacent to another symbol, terminal or operating device indicates that the operator must refer to an explanation in the Operating Instructions to avoid personal injury or damage to the meter.

**WARNING**

This **WARNING** symbol indicates a potentially hazardous situation, which if not avoided, could result in death or serious injury.

**CAUTION**

This **CAUTION** symbol indicates a potentially hazardous situation, which if not avoided, may result damage to the product.



This symbol advises the user that the terminal(s) so marked must not be connected to a circuit point at which the voltage with respect to earth ground exceeds (in this case) 600 VAC or VDC.

This symbol adjacent to one or more terminals identifies them as being associated with ranges that may, in normal use, be subjected to particularly hazardous voltages. For maximum safety, the meter and its test leads should not be handled when these terminals are energized.

This symbol indicates that a device is protected throughout by double insulation or reinforced insulation.

### PER IEC1010 OVERVOLTAGE INSTALLATION CATEGORY

#### OVERVOLTAGE CATEGORY I

Equipment of OVERVOLTAGE CATEGORY I is equipment for connection to circuits in which measures are taken to limit the transient overvoltages to an appropriate low level.

Note – Examples include protected electronic circuits.

#### OVERVOLTAGE CATEGORY II

Equipment of OVERVOLTAGE CATEGORY II is energy-consuming equipment to be supplied from the fixed installation.

Note – Examples include household, office, and laboratory appliances.

#### OVERVOLTAGE CATEGORY III

Equipment of OVERVOLTAGE CATEGORY III is equipment in fixed installations.

Note – Examples include switches in the fixed installation and some equipment for industrial use with permanent connection to the fixed installation.

#### OVERVOLTAGE CATEGORY IV

Equipment of OVERVOLTAGE CATEGORY IV is for use at the origin of the installation.

Note – Examples include electricity meters and primary over-current protection equipment

## CAUTIONS

- Improper use of this meter can cause damage, shock, injury or death. Read and understand this user manual before operating the meter.
- Always remove the test leads before replacing the battery or fuses.
- Inspect the condition of the test leads and the meter itself for any damage before operating the meter. Repair or replace any damage before use.
- Use great care when making measurements if the voltages are greater than 25VAC rms or 35VDC. These voltages are considered a shock hazard.
- Warning! This is a class A equipment. This equipment can cause interferences in the living quarters; in this case the operator can be required to carry out adequate measures.
- Always discharge capacitors and remove power from the device under test before performing Diode, Resistance or Continuity tests.
- Voltage checks on electrical outlets can be difficult and misleading because of the uncertainty of connection to the recessed electrical contacts. Other means should be used to ensure that the terminals are not "live".
- If the equipment is used in a manner not specified by the manufacturer, the protection provided by the equipment may be impaired.
- This device is not a toy and must not reach children's hands. It contains hazardous objects as well as small parts that the children could swallow. In case a child swallows any of them, please contact a physician immediately
- Do not leave batteries and packing material lying around unattended; they can be dangerous for children if they use them as toys
- In case the device is going to be unused for an extended period of time, remove the batteries to prevent them from training
- Expired or damaged batteries can cause cauterization on contact with the skin. Always, therefore, use suitable hand gloves in such cases
- See that the batteries are not short-circuited. Do not throw batteries into the fire.

## SAFETY INSTRUCTIONS

This meter has been designed for safe use, but must be operated with caution. The rules listed below must be carefully followed for safe operation.

1. **NEVER** apply voltage or current to the meter that exceeds the specified maximum:

Input Protection Limits	
Function	Maximum Input
V DC or V AC	600VDC/AC
mA AC/DC	400mA AC/DC 600V fast acting fuse
A AC/DC	10A AC/DC 600V fast acting fuse (20A for 30 sec max every 15 min)
Frequency, Resistance, Capacitance, Diode Test, Continuity, Temperature	250VDC/AC

2. **USE EXTREME CAUTION** when working with high voltages.
3. **DO NOT** measure voltage if the voltage on the "COM" input jack exceeds 600V above earth ground.
4. **NEVER** connect the meter leads across a voltage source while the function switch is in the current, resistance, or diode mode. Doing so can damage the meter.
5. **ALWAYS** discharge filter capacitors in power supplies and disconnect the power when making resistance or diode tests.
6. **ALWAYS** turn off the power and disconnect the test leads before opening the covers to replace the fuse or batteries.
7. **NEVER** operate the meter unless the back cover and the battery and fuse covers are in place and fastened securely.
8. If the equipment is used in a manner not specified by the manufacturer, the protection provided by the equipment may be impaired.

## Controls and Jacks

1. 4,000 count LCD display
2. MODE button
3. HOLD button
4. Function switch
5. COM input jack
6. 10A input jack
7. V,  $\Omega$ , CAP, Temp, Hz,  $\mu$ A and mA input jack
8. REL button
9. RANGE button
10. Battery compartment (rear)

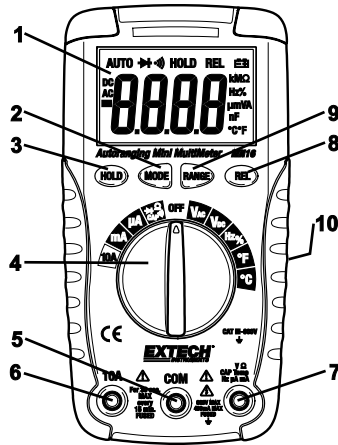

## Symbols and Annunciators

•)))	Continuity
	Diode test
	Low Battery
n	nano ( $10^{-9}$ ) (capacitance)
$\mu$	micro ( $10^{-6}$ ) (amps)
m	milli ( $10^{-3}$ ) (volts, amps)
A	Amps
k	kilo ( $10^3$ ) (ohms)
F	Farads (capacitance)
M	mega ( $10^6$ ) (ohms)
$\Omega$	Ohms
Hz	Hertz (frequency)
%	Percent (duty ratio)
AC	Alternating current
DC	Direct current
$^{\circ}$ F	Degrees Fahrenheit

V	Volts
REL	Relative
AUTO	Autoranging
HOLD	Display hold
$^{\circ}$ C	Degrees Centigrade

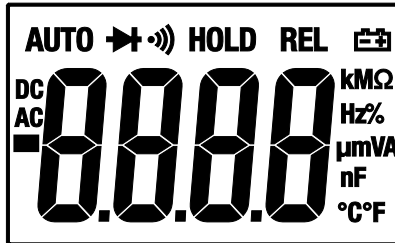

## Operating Instructions

**WARNING:** Risk of electrocution. High-voltage circuits, both AC and DC, are very dangerous and should be measured with great care.

1. ALWAYS turn the function switch to the **OFF** position when the meter is not in use.
2. If “OL” appears in the display during a measurement, the value exceeds the range you have selected. Change to a higher range.

### DC VOLTAGE MEASUREMENTS

**CAUTION:** Do not measure DC voltages if a motor on the circuit is being switched ON or OFF. Large voltage surges may occur that can damage the meter.

1. Set the function switch to the **VDC** position.
2. Insert the black test lead banana plug into the negative **COM** jack. Insert the red test lead banana plug into the positive **V** jack.
3. Touch the black test probe tip to the negative side of the circuit. Touch the red test probe tip to the positive side of the circuit.
4. Read the voltage in the display.

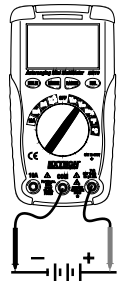

### AC VOLTAGE MEASUREMENTS

**WARNING:** Risk of Electrocution. The probe tips may not be long enough to contact the live parts inside some 240V outlets for appliances because the contacts are recessed deep in the outlets. As a result, the reading may show 0 volts when the outlet actually has voltage on it. Make sure the probe tips are touching the metal contacts inside the outlet before assuming that no voltage is present.

**CAUTION:** Do not measure AC voltages if a motor on the circuit is being switched ON or OFF. Large voltage surges may occur that can damage the meter.

1. Set the function switch to the **VAC** position.
2. Insert the black test lead banana plug into the negative **COM** jack. Insert red test lead banana plug into the positive **V** jack.
3. Touch the black test probe tip to the neutral side of the circuit. Touch the red test probe tip to the “hot” side of the circuit.
4. Read the voltage in the display.

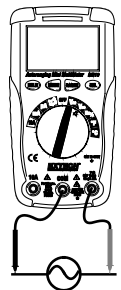

## DC CURRENT MEASUREMENTS

**CAUTION:** Do not make 20A current measurements for longer than 30 seconds. Exceeding 30 seconds may cause damage to the meter and/or the test leads.

1. Insert the black test lead banana plug into the negative **COM** jack.
2. For current measurements up to 4000 $\mu$ A DC;  
Set the function switch to the  **$\mu$ A** position and insert the red test lead banana plug into the  **$\mu$ A** jack.
3. For current measurements up to 400mA DC;  
Set the function switch to the **mA** position and insert the red test lead banana plug into the **mA** jack.
4. For current measurements up to 10A DC;  
Set the function switch to the **10A** position and insert the red test lead banana plug into the **10A** jack.
5. Press the **MODE** button to indicate “**DC**” on the display.
6. Remove power from the circuit under test, then open the circuit at the point where you wish to measure current.
7. Touch the black test probe tip to the negative side of the circuit.  
Touch the red test probe tip to the positive side of the circuit.
8. Apply power to the circuit.
9. Read the current in the display.

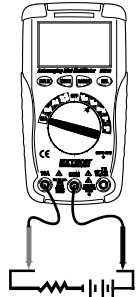

## AC CURRENT MEASUREMENTS

**CAUTION:** Do not make 20A current measurements for longer than 30 seconds. Exceeding 30 seconds may cause damage to the meter and/or the test leads.

1. Insert the black test lead banana plug into the negative **COM** jack.
2. For current measurements up to 4000 $\mu$ A AC;  
Set the function switch to the  **$\mu$ A** position and insert the red test lead banana plug into the  **$\mu$ A** jack.
3. For current measurements up to 400mA AC;  
Set the function switch to the **mA** position and insert the red test lead banana plug into the **mA** jack.
4. For current measurements up to 10A AC;  
Set the function switch to the **10A** position and insert the red test lead banana plug into the **10A** jack.
5. Press the **MODE** button to indicate “**AC**” on the display.
6. Remove power from the circuit under test, then open the circuit at the point where you wish to measure current.
7. Touch the black test probe tip to the negative side of the circuit.  
Touch the red test probe tip to the positive side of the circuit.
8. Apply power to the circuit.
9. Read the current in the display.

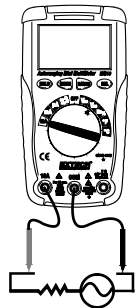

## RESISTANCE MEASUREMENTS

**WARNING:** To avoid electric shock, disconnect power to the unit under test and discharge all capacitors before taking any resistance measurements. Remove the batteries and unplug the line cords.

1. Set the function switch to the  $\Omega$  position.
2. Insert the black test lead banana plug into the negative **COM** jack. Insert the red test lead banana plug into the positive  $\Omega$  jack.
3. Press the **MODE** button to indicate " $\Omega$ " on the display.
4. Touch the test probe tips across the circuit or part under test.
5. Read the resistance in the display.

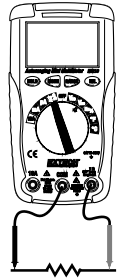

## CONTINUITY CHECK

**WARNING:** To avoid electric shock, never measure continuity on circuits or wires that have voltage on them.

1. Set the function switch to the  $\rightarrow$  position.
2. Insert the black lead banana plug into the negative **COM** jack. Insert the red test lead banana plug into the positive  $\Omega$  jack.
3. Press the **MODE** button to indicate " $\rightarrow$ " and " $\Omega$ " on the display.
4. Touch the test probe tips to the circuit or wire you wish to check.
5. If the resistance is less than approximately  $150\Omega$ , the audible signal will sound. If the circuit is open, the display will indicate "**OL**".



## DIODE TEST

1. Set the function switch to the  $\rightarrow$  position.
2. Insert the black test lead banana plug into the negative **COM** jack and the red test lead banana plug into the positive **V** jack.
3. Press the **MODE** button to indicate  $\rightarrow$  and **V** on the display.
4. Touch the test probes to the diode under test. Forward voltage will typically indicate 0.400 to 0.700V. Reverse voltage will indicate "**OL**". Shorted devices will indicate near 0V and an open device will indicate "**OL**" in both polarities.

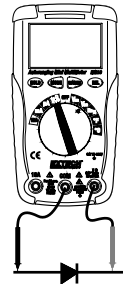



## TEMPERATURE MEASUREMENTS

1. Set the function switch to the **°F** or **°C** position.
2. Insert the Temperature Probe into the input jacks, making sure to observe the correct polarity.
3. Touch the Temperature Probe head to the part whose temperature you wish to measure. Keep the probe touching the part under test until the reading stabilizes (about 30 seconds).
4. Read the temperature in the display.

**Note:** The temperature probe is fitted with a type K mini connector. A mini connector to banana connector adaptor is supplied for connection to the input banana jacks.

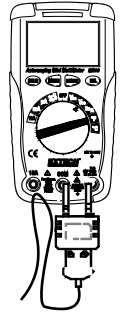

## CAPACITANCE MEASUREMENTS

**WARNING:** To avoid electric shock, disconnect power to the unit under test and discharge all capacitors before taking any capacitance measurements. Remove the batteries and unplug the line cords.

1. Set the rotary function switch to the **CAP** position.
2. Insert the black test lead banana plug into the negative **COM** jack. Insert the red test lead banana plug into the positive **CAP** jack.
3. Press the **MODE** button to indicate "**nF**" on the display.
4. Touch the test leads to the capacitor to be tested.
5. Read the capacitance value in the display.

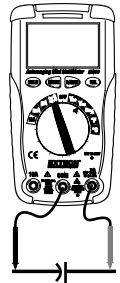

## FREQUENCY/DUTY CYCLE MEASUREMENTS

1. Set the rotary function switch to the "**Hz %**" position.
2. Press the **MODE** button to indicate "**Hz**" in the display.
3. Insert the black lead banana plug into the negative **COM** jack. Insert the red test lead banana plug into the positive **Hz** jack.
4. Touch the test probe tips to the circuit under test.
5. Read the frequency on the display.
6. Press the **MODE** button again to indicate "%" on the display.
7. Read the-duty cycle on the display.

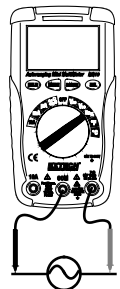

## AUTORANGING/MANUAL RANGE SELECTION

When the meter is first turned on, it automatically goes into Autoranging. This automatically selects the best range for the measurements being made and is generally the best mode for most measurements. For measurement situations requiring that a range be manually selected, perform the following:

1. Press the **RANGE** button. The "Auto" display indicator will turn off.
2. Press the **RANGE** key to step through the available ranges. Observe the decimal point and units displayed until the preferred range is located.
3. To exit the Manual Ranging mode and return to Autoranging, press and hold the **RANGE** key for 2 seconds.

**Note:** Manual ranging does not apply for the Capacitance and Frequency functions.

## RELATIVE MODE

The relative measurement feature allows you to make measurements relative to a stored zero reference value. A reference voltage, current, etc. can be stored and measurements made in comparison to that value. The displayed value is the difference between the reference value and the measured value.

1. Perform the measurement as described in the operating instructions.
2. Press the **REL** button to store (zero) the reading in the display. The "REL" indicator will appear on the display.
3. The display will now indicate the difference between the stored value and the measured value.
4. Press the **REL** button to exit the relative mode.

**Note:** The Relative function does not operate in the Frequency function.

## HOLD

The hold function freezes the reading in the display. Press the **HOLD** key momentarily to activate or to exit the **HOLD** function.

## AUTO POWER OFF

The auto off feature will turn the meter off after 30 minutes.

## LOW BATTERY INDICATION

The  icon will appear in the display when the battery voltage becomes low. Replace the battery when this appears.

## **Maintenance**

**WARNING:** To avoid electric shock, disconnect the test leads from any source of voltage before removing the back cover or the battery or fuse covers.

**WARNING:** To avoid electric shock, do not operate your meter until the battery and fuse covers are in place and fastened securely.

This MultiMeter is designed to provide years of dependable service, if the following care instructions are performed:

1. **KEEP THE METER DRY.** If it gets wet, wipe it off.
2. **USE AND STORE THE METER IN NORMAL TEMPERATURES.** Temperature extremes can shorten the life of the electronic parts and distort or melt plastic parts.
3. **HANDLE THE METER GENTLY AND CAREFULLY.** Dropping it can damage the electronic parts or the case.
4. **KEEP THE METER CLEAN.** Wipe the case occasionally with a damp cloth. DO NOT use chemicals, cleaning solvents, or detergents.
5. **USE ONLY FRESH BATTERIES OF THE RECOMMENDED SIZE AND TYPE.** Remove old or weak batteries so they do not leak and damage the unit.
6. **IF THE METER IS TO BE STORED FOR A LONG PERIOD OF TIME,** the batteries should be removed to prevent damage to the unit.

### **BATTERY REPLACEMENT**

1. Disconnect the test leads from the meter.
2. Remove the 2 Phillips head screws located on the back of the instrument and remove the battery cover.
3. Replace the 2 AAA batteries.
4. Secure the fuse/battery compartment cover.

Safety: Please dispose of batteries responsibly; never dispose of batteries in a fire, batteries may explode or leak. If the meter is not to be used for 60 days or more, remove the battery and store separately

### **FUSE REPLACEMENT**

1. Disconnect the test leads from the meter.
2. Remove the 2 Phillips head screws located on the back of the instrument and remove the battery cover.
3. Gently remove the fuse(s) and install the new fuse(s) into the holder(s).
4. Always use fuses of the proper size and value (500mA/600V ceramic fast blow for the mA /  $\mu$ A ranges, 10A/600V ceramic fast blow for the A range).
5. Secure the fuse/battery compartment cover.

**WARNING:** To avoid electric shock, do not operate your meter until the fuse cover is in place and fastened securely.

## Specifications

Function	Range	Resolution	Accuracy
DC Voltage (V DC)	4V	0.001V	±(1.2% reading + 2 digits)
	40V	0.01V	
	400V	0.1V	
	600V	1V	±(1.5% reading + 2 digits)
AC Voltage (V AC) (50 / 60Hz)	400mV*	0.1mV	±(1.5% reading + 15 digits)
	4V	0.001V	±(1.2% reading + 3 digits)
	40V	0.01V	±(1.5% reading + 3 digits)
	400V	0.1V	
	600V	1V	±(2.0% reading + 4 digits)
	*400mV range is not autoranging		
DC Current (A DC)	400µA	0.1µA	±(1.0% reading + 3 digits)
	4000µA	1µA	±(1.5% reading + 3 digits)
	40mA	0.01mA	
	400mA	0.1mA	
	10A	0.01A	±(2.5% reading + 5 digits)
AC Current (A AC)	400µA	0.1µA	±(1.5% reading + 5 digits)
	4000µA	1µA	±(1.8% reading + 5 digits)
	40mA	0.01mA	
	400mA	0.1mA	
	10A	0.01A	±(3.0% reading + 7 digits)
Resistance	400Ω	0.1Ω	±(1.2% reading + 4 digits)
	4kΩ	1Ω	±(1.0% reading + 2 digits)
	40kΩ	0.01kΩ	±(1.2% reading + 2 digits)
	400kΩ	0.1kΩ	
	4MΩ	0.001MΩ	
	40MΩ	0.01MΩ	±(2.0% reading + 3 digits)
Capacitance	40nF	0.01nF	±(5.0% reading + 30 digits)
	400nF	0.1nF	±(3.0% reading + 5 digits)
	4µF	0.001µF	
	40µF	0.01µF	
	100µF	0.1µF	±(5.0% reading + 5 digits)
Duty Cycle	0.1 to 99.9%	0.1%	±(1.2% reading + 2 digits)
	pulse width range: 100µs - 100ms (Frequency: 5Hz to 150kHz)		
Temp (type-K)	-4 to 1400°F	1°F	±(3.0% reading + 9°F/5°C)
	-20 to 750°C	1°C	(probe accuracy not included)

Function	Range	Resolution	Accuracy
Frequency	5.000Hz	0.001Hz	±(1.5% reading + 5 digits)
	50.00Hz	0.01Hz	
	500.0Hz	0.1Hz	±(1.2% reading + 3 digits)
	5.000kHz	0.001kHz	
	50.00kHz	0.01kHz	
	500.0kHz	0.1kHz	
	5.000MHz	0.001MHz	±(1.5% reading + 4 digits)
Sensitivity: >0.5V rms min. [ 1MHz; >3V rms > 1MHz			

**NOTE:**

Accuracy is stated at 18°C to 28°C (65°F to 83°F) and less than 75% RH.

<b>Diode Test</b>	Test current of 0.3mA typical, open circuit voltage 1.5V DC typical
<b>Continuity Check</b>	Audible signal will sound if the resistance is less than 150Ω (approx.), test current <0.3mA
<b>Temperature Sensor</b>	Requires type K thermocouple
<b>Input Impedance</b>	7.8MΩ
<b>AC Response</b>	Average responding
<b>ACV Bandwidth</b>	50Hz to 400Hz
<b>Display</b>	4,000 count liquid crystal
<b>Overrange indication</b>	“OL” is displayed
<b>Auto Power Off</b>	30 minutes (approximately)
<b>Polarity</b>	Automatic (no indication for positive); Minus (-) sign for negative
<b>Measurement Rate</b>	2 times per second, nominal
<b>Low Battery Indication</b>	“  ” is displayed if battery voltage drops below operating voltage
<b>Battery</b>	Two AAA batteries
<b>Fuses</b>	mA, μA ranges; 0.5A/600V ceramic fast blow A range; 10A/600V ceramic fast blow
<b>Operating Temperature</b>	5°C to 40°C (41°F to 104°F)
<b>Storage Temperature</b>	-20°C to 60°C (-4°F to 140°F)
<b>Operating Humidity</b>	Max 80% up to 31°C (87°F) decreasing linearly to 50% at 40°C (104°F)
<b>Storage Humidity</b>	<80%
<b>Operating Altitude</b>	2000meters (7000ft.) maximum.
<b>Weight</b>	225g (0.5lb) (includes holster).
<b>Size</b>	135 x 68 x 43mm (5.31” x 2.67” x 1.7”)
<b>Safety</b>	This meter is intended for indoor use and protected, against the users, by double insulation per EN61010-1 and IEC61010-1 3rd Edition (2010) to CAT III 600V; Pollution Degree 2. The meter also meets UL 61010-1, Third Edition (2012), CAN/CSA C22.2 No. 61010-1, Third Edition (2012), IEC61010-2-033 1st Ed. (2012).
<b>Approvals</b>	CE, ETL

**Copyright © 2013-2016 FLIR Systems, Inc.**

All rights reserved including the right of reproduction in whole or in part in any form

ISO-9001 Certified

[www.extech.com](http://www.extech.com)